

ATTENTION

READ ME FIRST

This manual is formatted for printing on letter paper, the USA standard. To print on A3 paper, choose "Fit to paper" while printing from Adobe Acrobat software.

You can download the latest version of the free Adobe Acrobat Reader from <http://www.adobe.com>

Save the forest. Print both sides.

ATENCIÓN

HEATHKIT OSCILLOSCOPE model OM - 1

Este documento es copia por escaner del manual arriba citado. Deseo que sea de la mayor utilidad para el público en general, y considero que la mejor forma de conseguirlo es liberalizando su distribución aunque manteniendo el Copyright. Por tanto, este documento es gratuito o "freeware" pero no comercializable o "public domain". Así pues, cualquiera que haga o distribuya copia del mismo deberá copiar el documento completo **incluida esta página**, y ya sea impresa o en formato electrónico, sea gratuita o cobrando como máximo y **únicamente** el valor del soporte, tendrá que dar al receptor de la misma el mismo derecho de libre copia y distribución que él tiene.

Este documento se distribuye con el deseo de que sea útil pero **SIN NINGUNA GARANTÍA**, ya sea implícita o explícita. En otro caso véase el manual original.

NOTICE

HEATHKIT OSCILLOSCOPE model OM - 1

This is a scanned copy of the above manual. I want this document to be of the greatest possible use to the public, and believe that the best way to achieve this is to make it free from proprietary claims, keeping it as freeware but not as public domain. If you create or distribute copies of this document, whether in printed or electronic form, whether gratis or for a fee (only to cover media), you must copy the full document **including this page** and must give the recipients all the rights that you have, including the right to freely copy and distribute it.

This document is distributed for informational purpose only and in the hope that it will be useful, but WITHOUT ANY WARRANTY, either express or even the implied warranty of MERCHANTABILITY or FITNESS FOR A PARTICULAR PURPOSE (you must look at the original instead).

©Miguel Bravo

Cartagena – España - CE

Octubre de 2005

mbravoc@wanadoo.es

PRICE \$1.00



- Cartagena
Assembling
and Using Your...

Heathkit

OSCILLOSCOPE

MODEL OM-1

HEATH COMPANY

A Subsidiary of Daystrom Inc.

BENTON HARBOR, MICHIGAN

STANDARD COLOR CODE — RESISTORS AND CAPACITORS

Scan by mbravoc@wanadoo.es

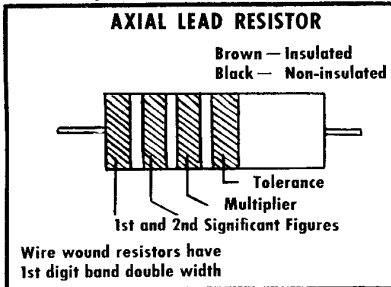

INSULATED UNINSULATED Color	FIRST RING BODY COLOR First Figure	SECOND RING END COLOR Second Figure	THIRD RING DOT COLOR Multiplier
BLACK	0	0	None
BROWN	1	1	0
RED	2	2	00
ORANGE	3	3	,000
YELLOW	4	4	0,000
GREEN	5	5	00,000
BLUE	6	6	000,000
VIOLET	7	7	0,000,000
GRAY	8	8	00,000,000
WHITE	9	9	000,000,000

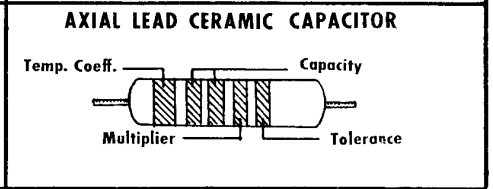
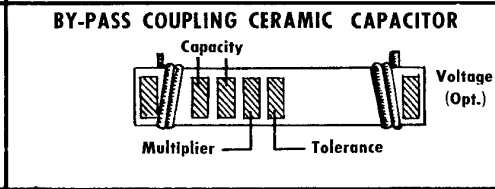
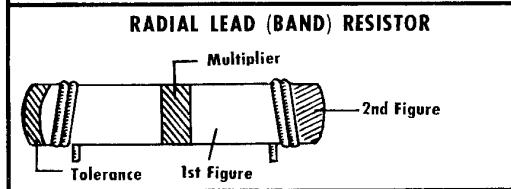
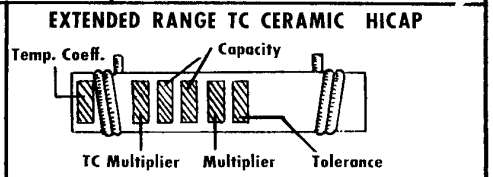
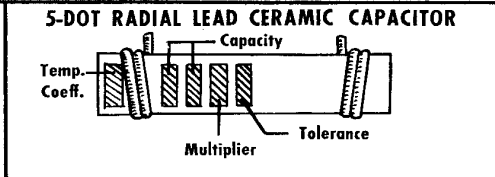
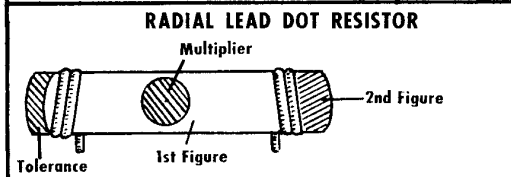
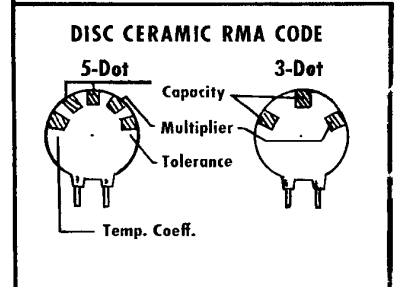

The standard color code provides all necessary information required to properly identify color coded resistors and capacitors. Refer to the color code for numerical values and the zeroes or multipliers assigned to the colors used. A fourth color band on resistors determines tolerance rating as follows: Gold = 5%, silver = 10%. Absence of the fourth band indicates a 20% tolerance rating.

The physical size of carbon resistors is determined by their wattage rating. Carbon resistors most commonly used in Heath-kits are 1/2 watt. Higher wattage rated resistors when specified are progressively larger in physical size. Small wire wound resistors 1/2 watt, 1 or 2 watt may be color coded but the first band will be double width.

MOLDED MICA TYPE CAPACITORS

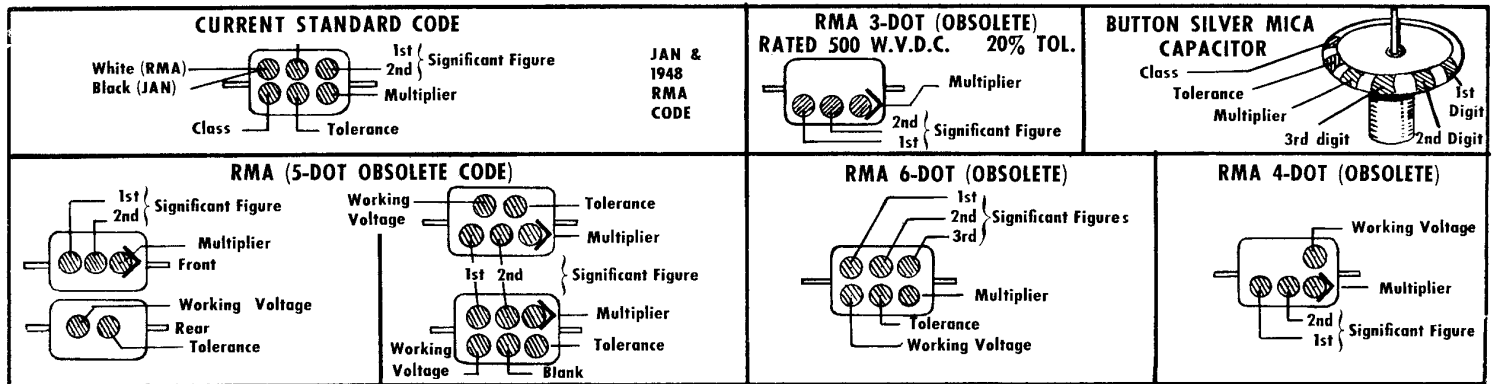

MOLDED PAPER TYPE CAPACITORS

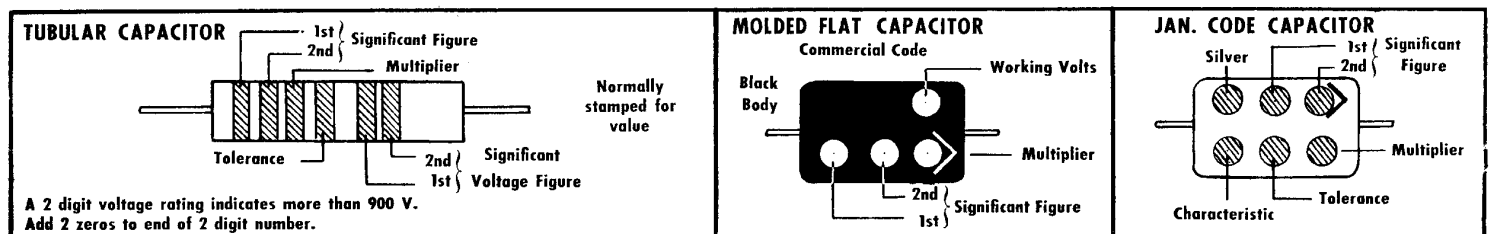

The tolerance rating of capacitors is determined by the color code. For example: red = 2%, green = 5%, etc. The voltage rating of capacitors is obtained by multiplying the color value by 100. For example: orange = 3 × 100 or 300 volts. Blue = 6 × 100 or 600 volts.

In the design of Heathkits, the temperature coefficient of ceramic or mica capacitors is not generally a critical factor and therefore Heathkit manuals avoid reference to temperature coefficient specifications.

ASSEMBLY AND OPERATION OF THE HEATHKIT OSCILLOSCOPE

MODEL OM-1

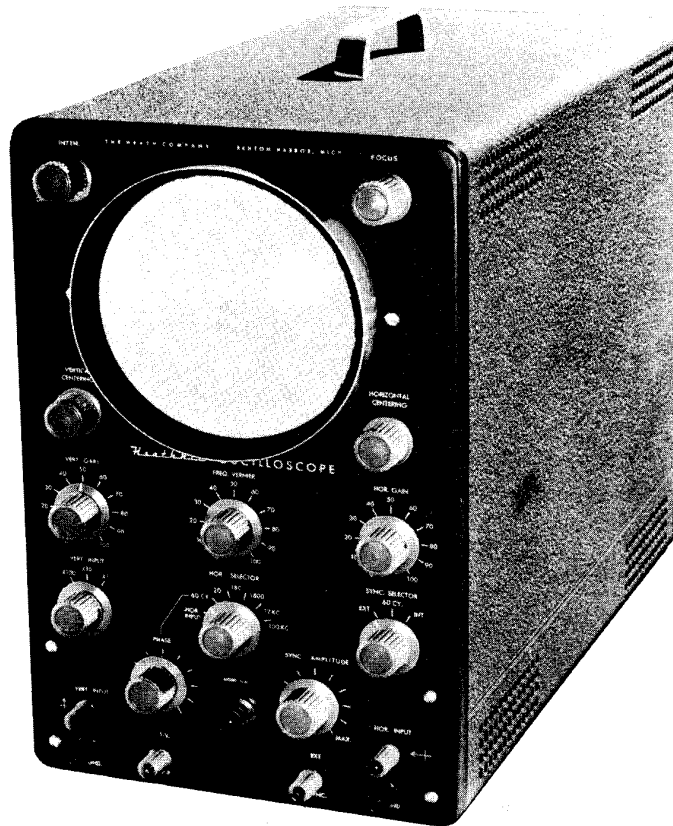

SPECIFICATIONS

Vertical:

Frequency Response.....	±3 db 2 cps to 200 kc
	±6 db 1 cps to 400 kc
Sensitivity.....	0.09 volt RMS per inch P-P deflection at 1 kc
Input Impedance.....	50 μ f shunting 1.5 megohms at X1
	40 μ f shunting 1.5 megohms at X10 and X100

Horizontal:

Frequency Response.....	±3 db 2 cps to 200 kc
	±6 db 1 cps to 400 kc
Sensitivity.....	0.2 volt RMS per inch P-P deflection at 1 kc
Input Impedance.....	25 μ f shunting 10 megohms

Sweep Generator..... Multivibrator 20-100,000 cps

Tube Complement.....

- 1 - 5BP1 cathode ray tube
- 3 - 12AU7 vertical and horizontal cathode follower and amplifier. Horizontal deflection amplifier
- 1 - 12AT7 vertical deflection amplifier
- 1 - 12AX7 multivibrator
- 1 - 6X4 low voltage rectifier
- 1 - 1V2 high voltage rectifier

Power Requirements..... 105-125 volts AC, 50/60 cycles, 45 watts

Dimensions..... 8 5/8" wide x 14 1/8" high x 18" deep

Net Weight..... 19 lbs.

Shipping Weight..... 24 lbs.

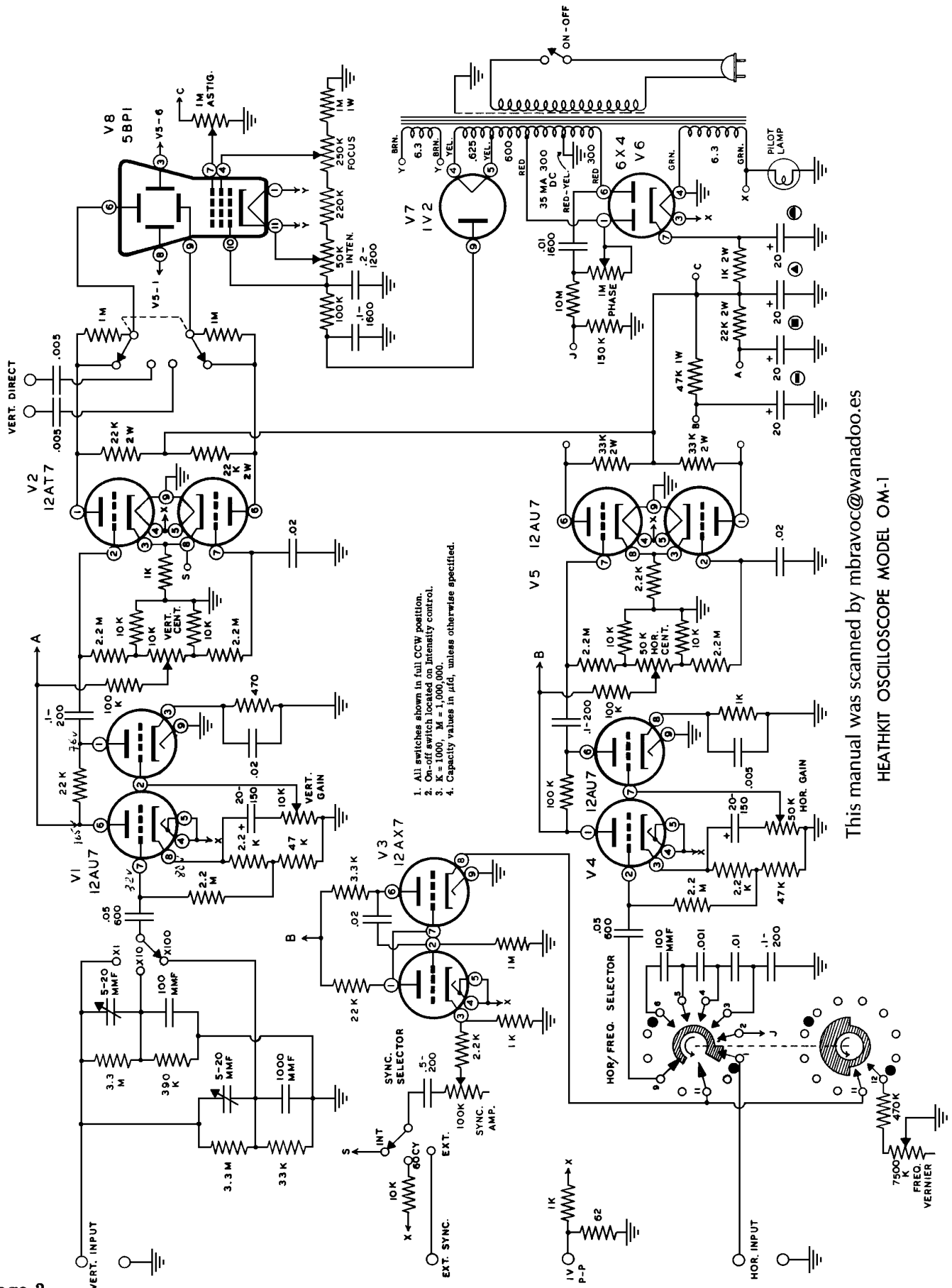

This manual was scanned by mbravoc@wanadoo.es
 HEATHKIT OSCILLOSCOPE MODEL OM-1

INTRODUCTION

The cathode ray oscilloscope is without a doubt the most versatile electronic instrument available today. Basically, it is an indicating device which can display in usable form the actual voltage variations in an electrical quantity as compared to time. This however, is merely its basic function and it would be impossible at this time to enumerate all of its qualifications. It is the type of instrument for which the operator can continue to find new applications even after many years of use.

Some of the many desirable features are as follows:

1. It displays instantly information that otherwise would require hours of experimentation.
2. Waveforms can easily be photographed and retained for future reference.
3. It usually has a negligible effect on the characteristics of a circuit under test.
4. It has an extremely wide range of sensitivity.
5. It is rugged, dependable and not easily damaged by overload or surges.

CONSTRUCTION HINTS

The construction of the Heathkit model OM-1 Oscilloscope has been simplified tremendously by the use of an etched circuit board. The major portion of the complete oscilloscope circuit is already wired except for the addition of sockets and the placement of resistors and condensers. This extremely new development in the kit instrument field represents countless advantages for the kit builder. It practically assures him of optimum performance by eliminating the factors that previously caused the lack of uniformity between individual kits.

No longer must you worry about long or improperly dressed leads in critical parts of the circuit. The possibility of poor performance due to wiring errors has been reduced to a bare minimum. Component values are indicated directly on the circuit board itself, thus eliminating the need for page after page of tedious instructions. Perhaps the principal advantages are in the fact that construction time is substantially reduced and that each completed kit will be equal in every respect to the carefully prepared sample models built up in the Heath engineering laboratories.

Printed circuits in themselves are not entirely new, but their use in a kit instrument is definitely an innovation. There are a number of methods by which the circuit board is manufactured, but basically it is merely an insulating material upon which a metal conductor pattern is impressed. The pattern is usually applied to a copper plated board made of a laminated phenolic material by photography or one of the many printing processes. The excess copper is then etched away leaving only the desired pattern. Some methods include the application of a silver coating to facilitate soldering and conductivity. Finally, the holes are drilled or punched for the proper mounting of parts.

When soldering to the copper circuit pattern, discretion should be used in order that the board will not be damaged by excessive heat. The actual technique is not at all difficult, but the soldering iron itself is an important factor. The tip should be small such as those used in soldering pencils and the rating of the iron should not exceed 50 watts. Very little solder is required and it must be of the rosincore variety. A "tin versus lead" content of 60-40 or 40-60 is acceptable. Acid and paste fluxes will damage the board beyond repair. It is recommended that the soldering instructions at the point in the manual where the soldering of the board is begun, be read very carefully. For the other connections in the kit, the notes on the inside of the rear cover will be more than sufficient.

The Heathkit model OM-1 Oscilloscope, when properly constructed will provide years of satisfactory service. We therefore urge you to take all the time that is necessary to do a good job. Do not hurry the work and you will be rewarded with a greater sense of confidence both in the equipment and in your own workmanship.

This manual is supplied to assist you in every way to complete the instrument with the least possible chance of error. We suggest that you take a few minutes now and read the manual through before work is started. This will enable you to proceed with more certainty when construction is begun.

The large fold-in pictorials can be attached to the wall above your work bench for ready reference. They are repeated in smaller form within the manual. The manual itself should be retained for the future use and maintenance of the instrument.

UNPACK THE KIT CAREFULLY AND CHECK EACH PART AGAINST THE PARTS LIST. In so doing, you will become acquainted with each part. Refer to the charts and other information on the inside covers of the manual to help you identify any part about which there may be a question. If some shortage is found in checking the parts, please notify us promptly and return the inspection slip with your letter to us. Hardware items are counted by weight and if a few are missing, please obtain them locally if at all possible.

Use only the best rosin core solder, preferably one containing the new activated fluxes, such as Kester "Resin-Five," Ersin "Multicore" or similar types.

Resistors and controls generally have a tolerance rating of $\pm 20\%$ unless otherwise stated in the parts list. Therefore a 100 K Ω resistor may test anywhere from 80 K Ω to 120 K Ω . (The letter K is commonly used to designate a multiplier of 1000.) Tolerances on condensers are generally even greater. Limits of $+100\%$ and -50% are common for electrolytic condensers. The parts furnished with your Heathkit have been specified so as to not adversely affect the operation of the finished instrument.

In order to expedite delivery to you, we are occasionally forced to make minor substitutions of parts. Such substitutions are carefully checked before they are approved and the parts supplied will work satisfactorily. By checking the parts list for resistors, for example, you may find that a 2.2 megohm resistor has been supplied in place of a 2 megohm as shown in the parts list. These changes are self-evident and are mentioned here only to prevent confusion to you in checking the contents of your kit. We strongly urge that you follow the wiring and parts layout shown in the manual. Although most of the critical connections are etched into the circuit board, some of the others may affect the characteristics of the instrument if their positions are radically changed from the layout as described in this manual.

STEP-BY-STEP ASSEMBLY AND WIRING

A space is provided in front of each step so that you can check off each operation as it is completed. This method will prevent confusion if your work is interrupted.

Unless otherwise specified, always use the standard 6-32 x 3/8" screws with #6 lockwashers under the 6-32 nuts for the installation of parts.

- () Refer to Pictorials 1 and 2 on Page 5. Connect the CR tube support bracket to the chassis using 6-32 hardware. At position A, install a 3-lug terminal strip under the lockwasher. At position B, use a #6 solder lug instead of a lockwasher. Place these components as shown in Pictorial 1.
- () Install a 3-lug terminal strip at C. CAUTION: This strip is different than the one at A. Make sure that the correct part is used in each instance.
- () Install a 2-lug terminal strip at D.
- () Using 3-48 screws and nuts (no lockwashers), mount the 7-pin miniature tube socket at V6. The flat side of the socket must be placed against the underside of the chassis as shown in Pictorial 1. The blank space between pins 1 and 7 should be positioned as shown.

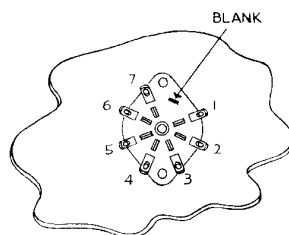

NUMBERING ON 7-PIN TUBE SOCKET

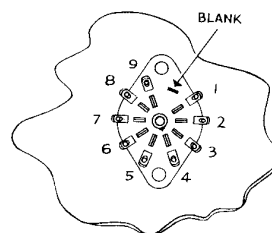

NUMBERING ON 9-PIN TUBE SOCKET

Figure 1

Scan by mbravoc@wanadoo.es

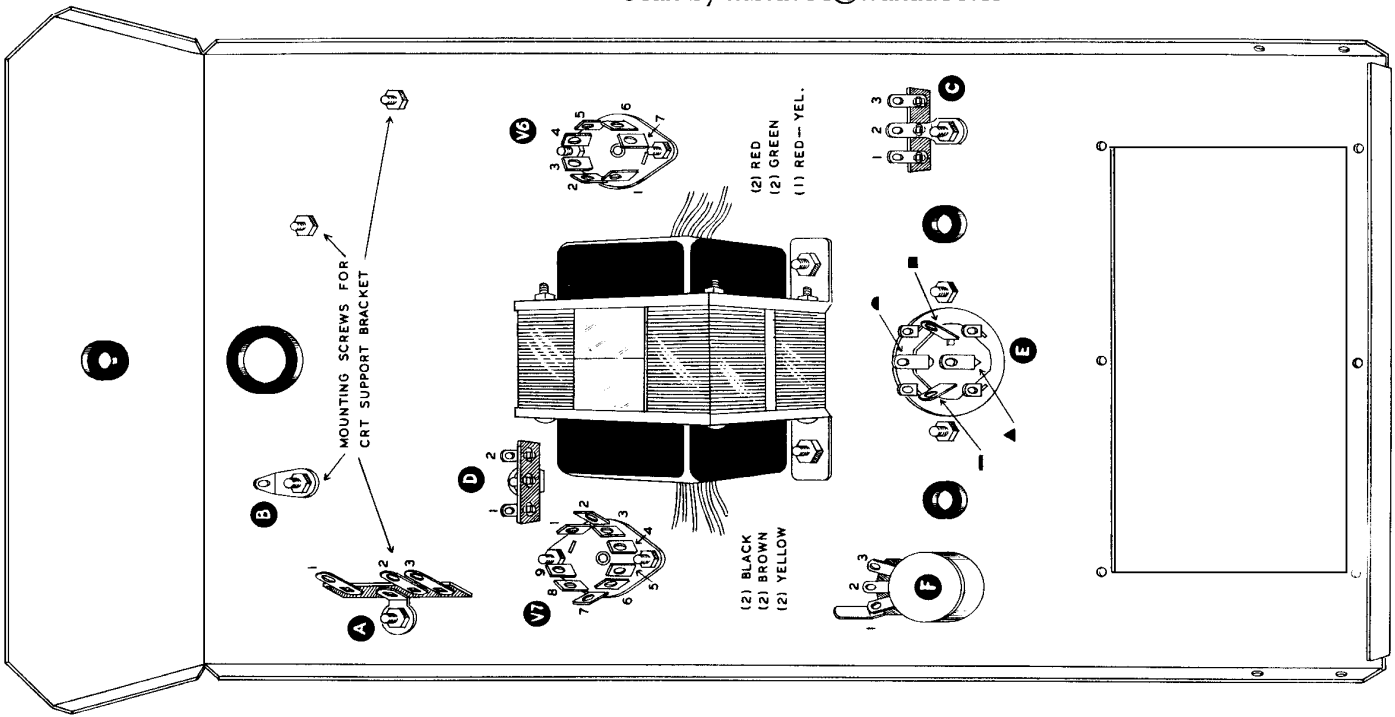

PICTORIAL 1

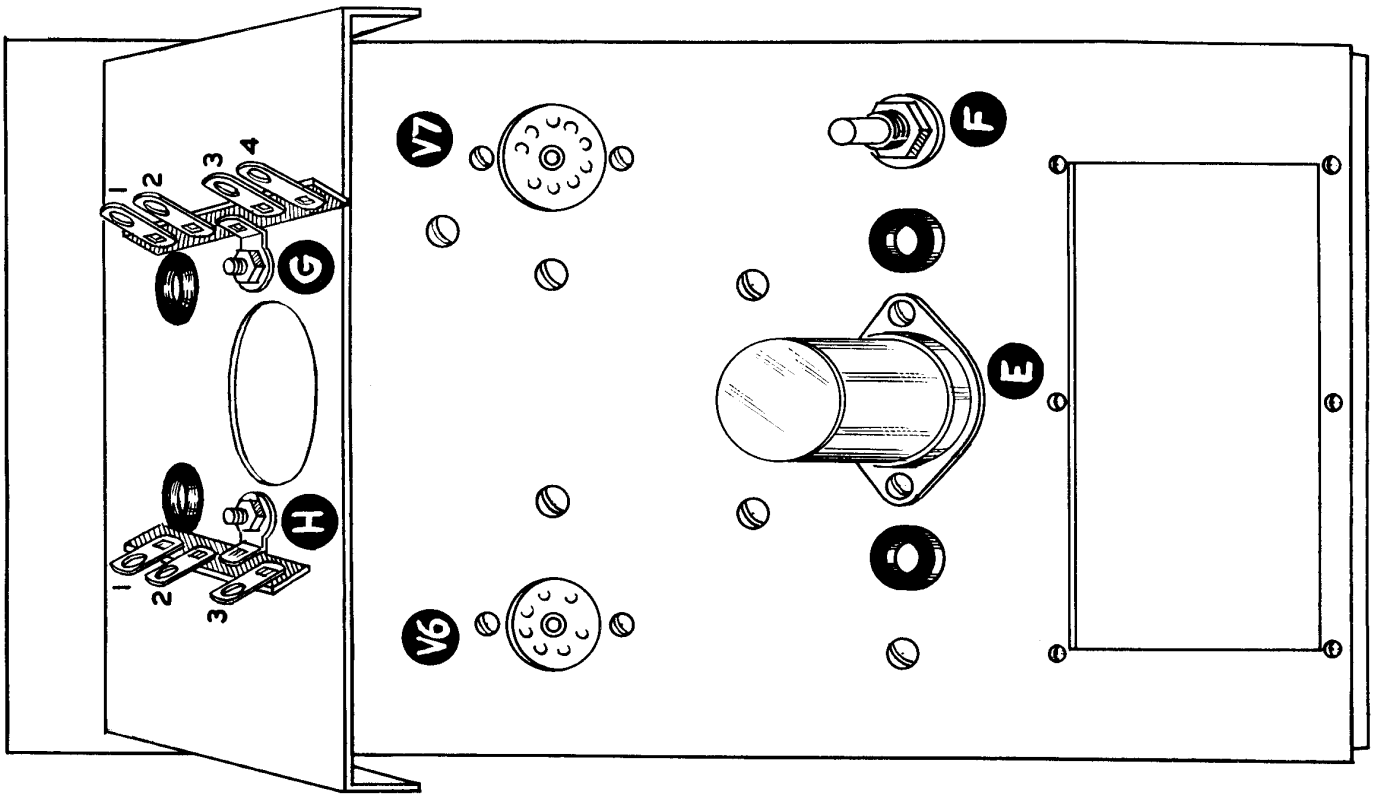

PICTORIAL 2

- () In the same manner, install the 9-pin miniature tube socket at V7. Note the positioning of the blank space between pins 1 and 9.
- () Install the metal condenser mounting wafer at E. The wafer should lie against the top side of the chassis as shown.
- () Insert 3/8" rubber grommets in each of the two holes on either side of the condenser mounting wafer and in the center hole in the large chassis skirt.
- () Insert a 3/4" rubber grommet in the hole directly below the large chassis skirt in Pictorial 1.

- () From the topside of the chassis, insert the electrolytic filter condenser 25-21, into the condenser mounting wafer at E. Carefully identify the four inner lugs and position them as shown. While holding the condenser firmly in place, twist each of the four mounting prongs about 1/8 turn. This will secure the filter condenser in place.

Figure 2

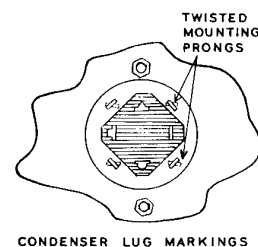

- () Slip a control solder lug over the shaft of the 1 megohm Astigmatism control as shown. Insert the shaft of the control through hole F in the chassis. Tighten the control in place with a control nut over a flat nickel washer.

- () Now bend the solder lug back until it contacts lug 1 of the control.

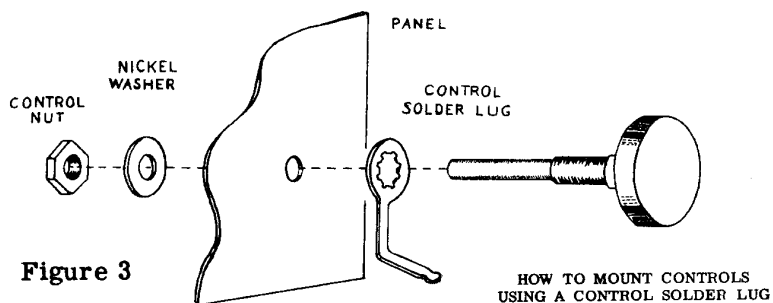

Figure 3

- () Examine the power transformer and identify the color-coded wires coming out on either side. Install the transformer using 8-32 hardware. All brown, yellow and black leads should come out near the 9-pin socket.
- () Referring to Pictorial 2 and Figure 4, mount the 4-lug terminal strip on the CR tube support bracket at G. Be sure to include one of the small angle brackets as shown.
- () In the same manner, install a 3-lug terminal strip and the other angle bracket at H.
- () Now insert 3/8" rubber grommets in the two 3/8" holes in the CR tube support bracket.

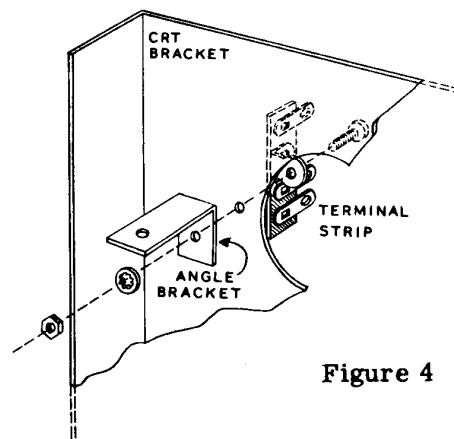

Figure 4

Scan by mbravoc@wanadoo.es

NOTE: ALL GUARANTEES ARE VOIDED AND WE WILL NOT REPAIR OR SERVICE INSTRUMENTS IN WHICH ACID CORE SOLDER OR PASTE FLUXES HAVE BEEN USED. WHEN IN DOUBT ABOUT SOLDER, IT IS RECOMMENDED THAT A NEW ROLL PLAINLY MARKED "RO SIN CORE RADIO SOLDER" BE PURCHASED.

All wire referred to is insulated hookup wire unless otherwise specified. The ends should be stripped of insulation about 1/4" back. (S) means to solder the terminal immediately, making sure that the solder contacts all wires connected to that terminal. (NS) means do not solder yet because other connections are to be made to that terminal later.

- () At the astigmatism control F, solder lug 1 to the control solder lug which has been adjusted to contact lug 1. Refer to Pictorial 3.
- () At the low voltage filter condenser E, solder any one of the four twisted mounting prongs to the metal condenser mounting wafer. This will maintain a good ground connection for the filter circuit.
- () Connect a wire from lug 3 (S) of the astigmatism control F to the ▲ marked lug (NS) of the filter condenser E. Dress as shown.
- () Strip both ends of a 5" piece of wire and connect one end to lug ▲ (NS) of filter condenser E. Run the other end through the grommet located next to the astigmatism control F. Leave this end free.
- () In the same manner, connect one end of a 5 3/4" piece of wire to lug — (NS) of condenser E. Run the other end through the same grommet and leave it free.
- () Connect one end of a 5" piece of wire to lug — (NS) of E and again insert the other end through the same grommet.
- () Connect a wire from lug ▲ (NS) of E to pin 7 (S) of the 6X4 tube socket V6.
- () Connect one end of a 5 3/4" piece of wire to lug ■ (NS) of condenser E. Insert the other end through the grommet located next to terminal strip C. Leave this end free.

NOTE: All resistors have a 1/2 watt rating unless otherwise specified. They are the smallest size with a body length of 3/8" and a diameter of 1/8". 1 watt resistors are 9/16" long and have a diameter of 7/32". 2 watt resistors are about 11/16" long and have a diameter of 5/16". Be sure to use the correct size in each position. Unless otherwise stated, disregard the "outside foil" markings on tubular condensers.

- () Connect a 47 K Ω 1 watt resistor (yellow-violet-orange) from E ▲ (NS) to E — (S).
- () Connect a 22 K Ω 2 watt resistor (red-red-orange) from E ▲ (NS) to E ■ (S).
- () Now connect a 1 K Ω 2 watt resistor (brown-black-red) from E ▲ (S) to E ▲ (S).
- () Connect a wire from pin 1 (NS) of socket V6 to lug 1 (NS) of the terminal strip C.
- () Strip both ends of a 7 1/2" piece of wire and connect one end to pin 3 (NS) of socket V6. Run the other end through the grommet next to terminal strip C. Leave this end free.
- () Connect a wire from pin 4 (NS) of socket V6 to lug 2 (NS) of terminal strip C.
- () Connect a .01 μ fd 1600 volt DC tubular condenser to lug 3 (NS) of terminal strip C. Wire the other lead to pin 6 (NS) of socket V6.
- () Connect the red-yellow lead coming out of the power transformer to lug 2 (NS) of terminal strip C.
- () Twist the two red transformer leads together once or twice and connect either one to pin 1 (S) of socket V6. Wire the other red lead to pin 6 (S) of the same socket.
- () Twist the two green transformer leads together and connect either one to pin 3 (S) of V6. Connect the other green lead to pin 4 (S) of V6.

- () On the other side of the transformer, twist the two yellow leads together and connect either one to pin 5 (S) of socket V7. Wire the other yellow lead to pin 4 (S) of the same socket.
- () Twist the black leads together and dress them along the side of the chassis as shown. Connect either black lead to lug 2 (NS) of terminal strip A. Wire the other black lead to lug 3 (NS) of terminal strip A.
- () Twist the two brown leads together and dress them along the same side of the chassis. Run the brown leads beyond terminal strip A and solder lug B and through the large 3/4" grommet near the chassis skirt. Connect either brown lead to lug 4 (NS) of terminal strip G on the CR tube support bracket. The other brown lead is then wired to lug 3 (NS) of the same strip.
- () Identify the cable assembly consisting of color-coded wires. At one end there will be only four free wires colored red, orange, yellow and blue. Insert this end of the cable into the large 3/4" grommet from the underside of the chassis. These cabled wires are already cut to proper length and stripped. On the CR tube support bracket, connect the yellow wire to lug 3 (NS) of terminal strip G. See Pictorial 4.
- () Connect the red wire to lug 2 (NS) of terminal strip G.
- () Connect the blue wire to lug 2 (NS) of terminal strip H.
- () Connect the orange wire to lug 1 (NS) of terminal strip H.
- () On the underside of the chassis, dress the cable parallel to the brown transformer leads and straight down the chassis edge. An inch or two below terminal strip A, the orange lead branches off. Draw the cable down the chassis edge only far enough to connect the orange lead to lug 2 (S) of the astigmatism control F.
- () Coming out of the cable along with the orange lead will be two white and two red leads. Connect either white lead to lug 1 (NS) of terminal strip A.
- () Connect the other white lead to lug 3 (S) of terminal strip A.
- () Dress both of the red leads between socket V7 and terminal strip D as shown. Connect both red leads to lug 2 (NS) of terminal strip D.
- () Select the line cord and tin each lead end to hold the copper strands together and make soldering easier. This is accomplished by heating each stripped end with the soldering iron and then flowing on a small amount of solder until the individual copper strands are bonded together.
- () Slip the line cord into the chassis through the 3/8" rubber grommet in the chassis skirt. Tie a knot in the cord about 6" from the end for strain relief. Connect either lead to lug 1 (S) of terminal strip A. Wire the other lead to lug 2 (S) of the same strip.
- () Position the .1 μ fd 1600 volt DC paper tubular condenser as shown and connect one lead to solder lug B (NS). Pass the other condenser lead through lug 1 (NS) of terminal strip D to pin 9 (S) of socket V7.
- () In the same manner, connect either lead of the .2 μ fd 1200 volt DC paper tubular condenser to solder lug B (S). Wire the other lead to lug 2 (NS) of terminal strip D.
- () Now connect a 100 K Ω resistor (brown-black-yellow) from lug 1 (S) to lug 2 (S) of terminal strip D.

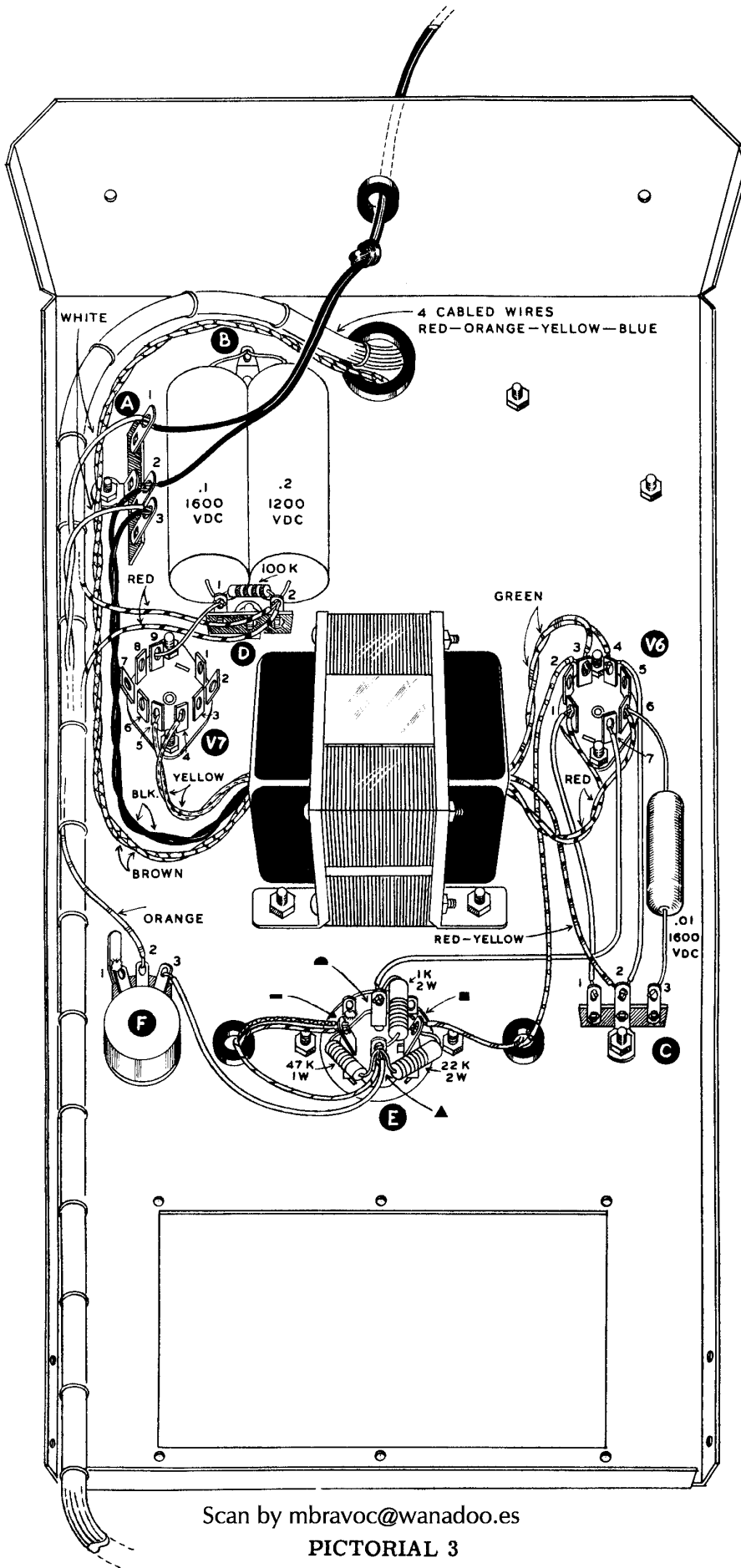

- () Lay aside the chassis for the time being and set up the "direct input bracket" as shown. Install the DPDT slide switch SW, using 6-32 hardware.

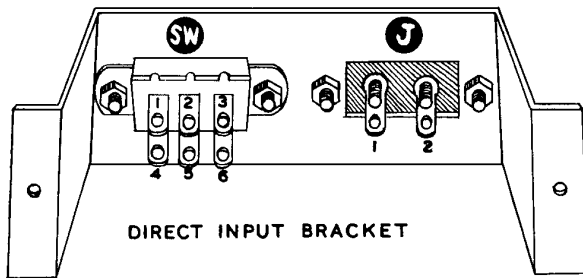

Figure 5

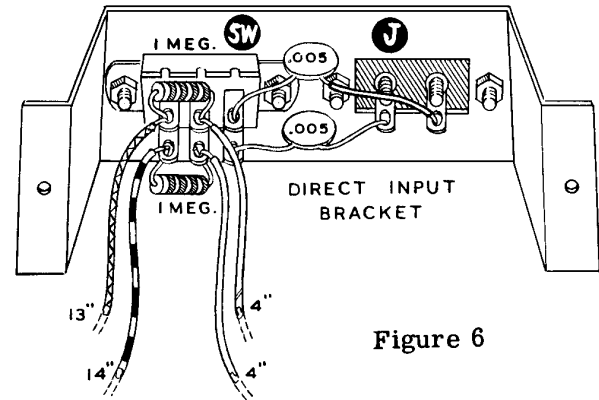
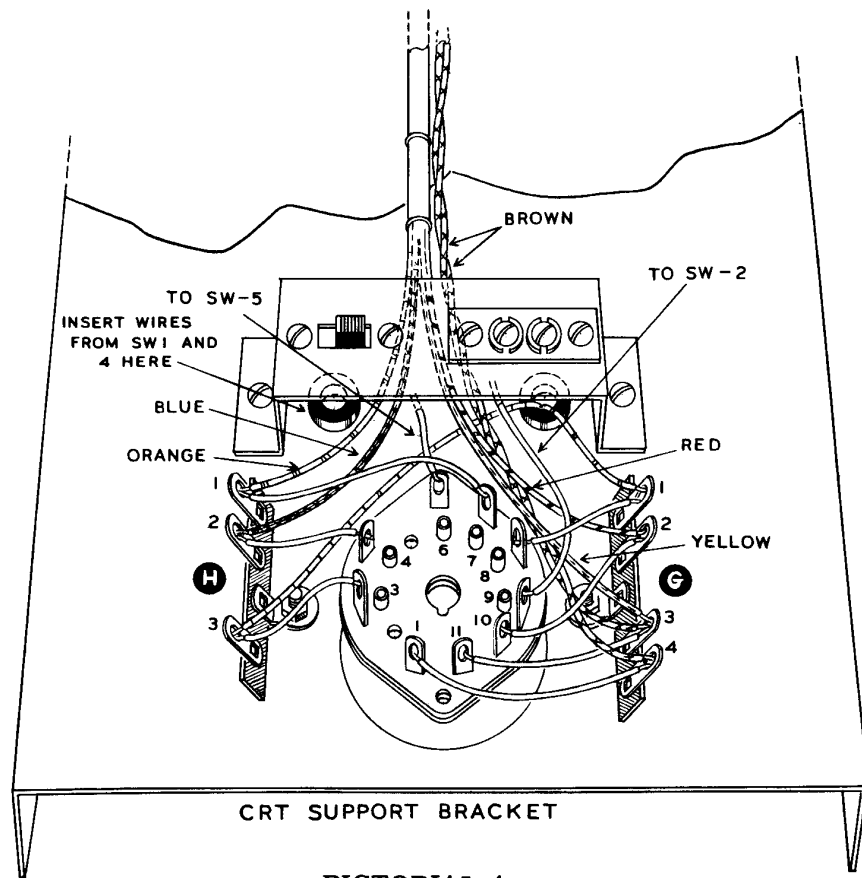

Figure 6

- () Now install the 2-screw terminal strip J from the opposite side of the bracket so that the lugs extend through the bracket hole.
- () Connect a .005 μ fd disc condenser from lug 6 (S) of switch SW to lug 1 (S) of the terminal strip J. Dress as shown.
- () Connect another .005 μ fd disc condenser from lug 3 (S) of switch SW to lug 2 (S) (use sleeving) of terminal strip J.
- () Wire a 1 megohm resistor (brown-black-green) from lug 1 (NS) to lug 2 (NS) of switch SW.
- () Connect another 1 megohm resistor from lug 4 (NS) to lug 5 (NS) of switch SW.
- () Connect one end of a 13" piece of wire to lug 1 (S) of switch SW. Leave the other end free.
- () Connect one end of a 14" piece of wire to lug 4 (S) of switch SW. Leave the other end free.
- () Connect a 4" piece of wire to lug 2 (S) of switch SW. Leave the other end free.
- () Connect another 4" piece of wire to lug 5 (S) of switch SW. Leave the other end free.
- () The long leads attached to lugs 1 and 4 of switch SW can now be drawn through the 3/8" grommet near terminal strip H on the CR tube bracket as shown. Now install the direct input bracket on the CR tube bracket using 6-32 hardware. Do not pass the short leads at lugs 2 and 5 of switch SW through the grommet.
- () Connect the free end of the lead from lug 2 of switch SW to pin 9 (S) of the 11-pin CRT socket. The socket will now be hanging by one lead. Refer to Pictorial 4 for proper positioning.
- () Connect the short lead from lug 5 of switch SW to pin 6 (S) of the CRT socket.
- () Connect one end of a 16 1/2" piece of wire to lug 3 (NS) of terminal strip H on the CR tube bracket. Pass the other end of the wire under the colored cable wires and run it through the 3/8" grommet located near terminal strip G. Leave this end free.
- () Now connect one end of a 14" piece of wire to lug 1 (NS) of terminal strip G. Insert the other end into the same grommet near G and leave this end free.
- () Cut and strip both ends of seven pieces of wire, each of which should be 4" long. Connect the first wire from lug 1 (S) of terminal strip G to pin 8 (S) of the CRT socket.
- () Connect the second wire from lug 2 (S) of terminal strip G to pin 10 (S) of the CRT socket.



PICTORIAL 4

- () The third wire should now be connected from lug 3 (S) of terminal strip G to pin 11 (S) of the CRT socket.
- () Connect the fourth wire from lug 4 (S) of terminal strip G to pin 1 (S) of the CRT socket.
- () Connect the fifth wire from lug 1 (S) of terminal strip H to pin 7 (S) of the CRT socket.
- () Connect the sixth wire from lug 2 (S) of terminal strip H to pin 4 (S) of the CRT socket.
- () Finally, connect the seventh wire from lug 3 (S) of terminal strip H to pin 3 (S) of the CRT socket.

NOTE: When installing controls and switches, flatten out any locating prong that might interfere with a secure mounting to the panel.

- () Refer to Pictorial 5 on Page 12 and begin the assembly of the parts to the front panel. Install the 250 K Ω FOCUS control at K. Use a control solder lug instead of a control lockwasher. Position the lugs as shown.
- () Now install the 50 K Ω INTEN. control at L. Notice that this control has two extra lugs at the rear and one extra on the side.
- () Install the 50 K Ω HORIZONTAL CENTERING control at M.
- () Install the 10 K Ω VERTICAL CENTERING control at N.

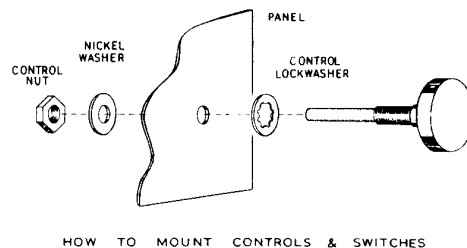
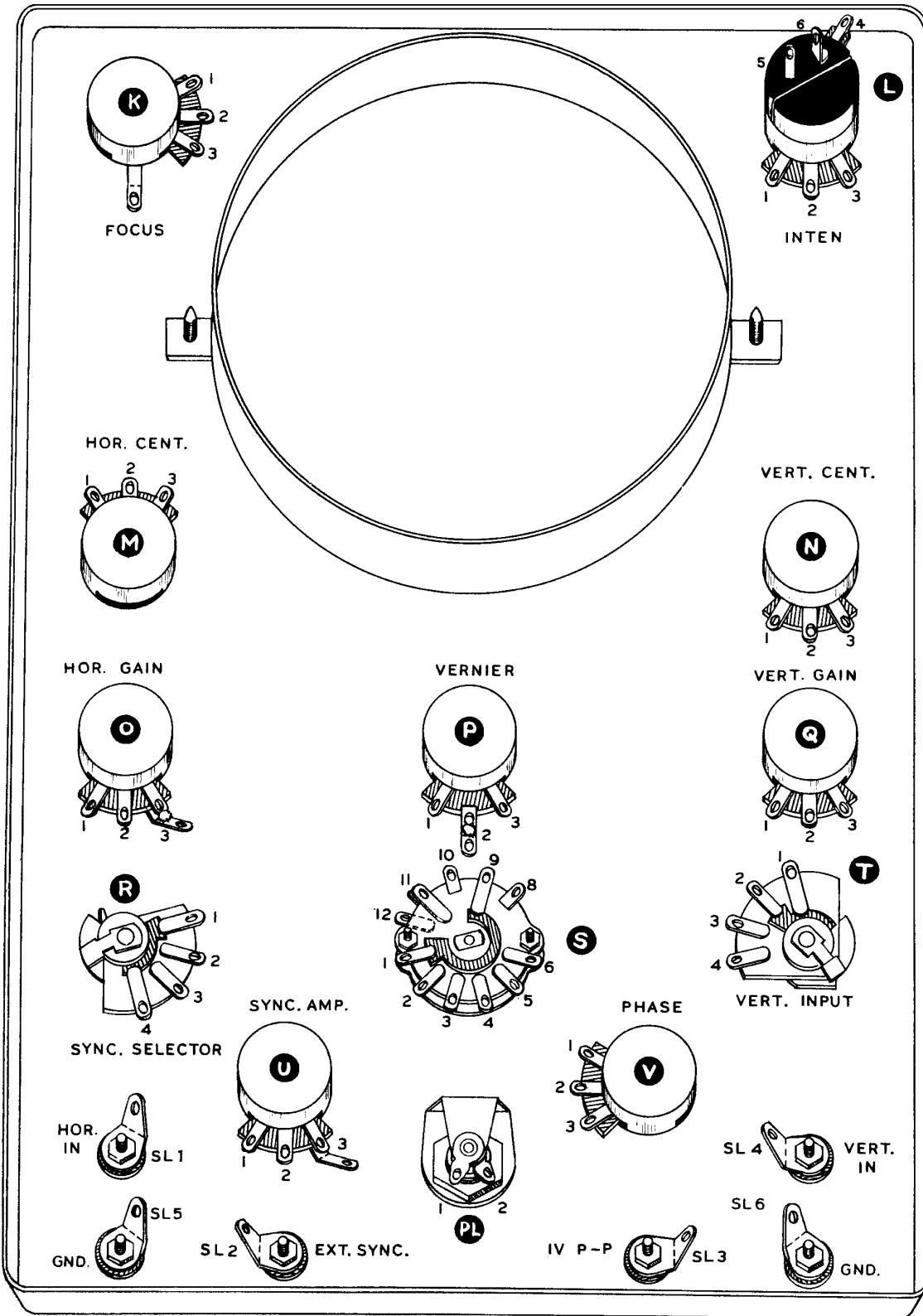

Figure 7



Scan by mbravoc@wanadoo.es

PICTORIAL 5

- () Using a control solder lug, mount the 50 K Ω HOR. GAIN control at O. Bend the control solder lug back to contact lug 3 and solder.
- () Use another control solder lug and install the 7500 K Ω FREQ. VERNIER control at P. Bend back the control solder lug and solder it to lug 2 of the control.
- () Install the 10 K Ω VERT. GAIN control at Q, using the regular lockwasher, flat washer and nut.
- () Install one of the 3-position rotary switches 63-47 at position R. Orient the lugs as shown.
- () Similarly, mount the other 3-position switch at T.
- () Now install the 6-position rotary switch 63-83 at position S. Before tightening the control nut, rotate the switch so that lugs 9 and 10 are closest to the FREQ. VERNIER control P.

- () Refer to Figure 8 and mount the pilot light assembly at PL. The bushing, lamp and jewel are installed from the front of the panel.
- () Now install the 100 K Ω SYNC. AMPLITUDE control at U. Use a control solder lug, but do not solder it to any of the control lugs.

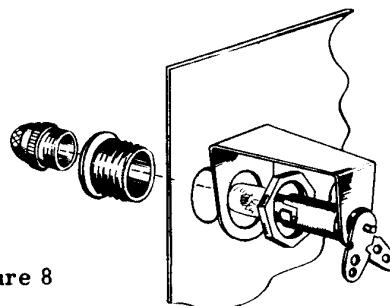

Figure 8

PILOT LIGHT ASSEMBLY

- () Install the 1 megohm PHASE control at V.
- () Install binding post bases in each of the six holes at the bottom of the panel. Refer to Figure 5 and use the insulator bushings with a #6 solder lug under the nut. Position the solder lugs as shown in Pictorial 5 at positions SL1, SL2, SL3, SL4, SL5 and SL6.
- () Mount the CR tube ring as shown. The mounting brackets should rest against the inside surface of the panel and the seam in the ring should be downward. Secure with #6 sheet metal screws.

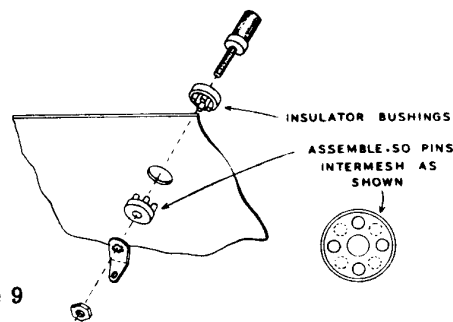
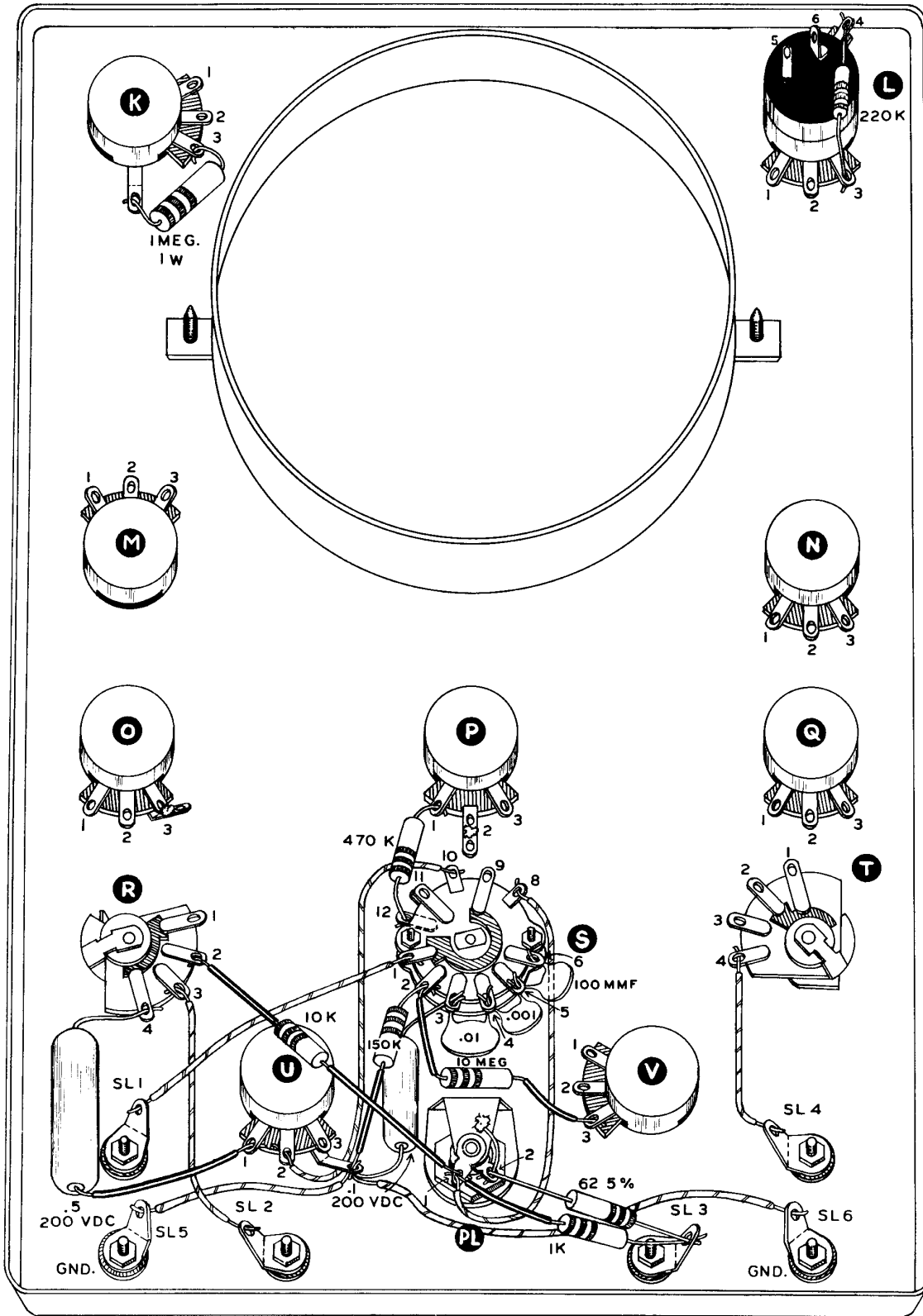

Figure 9

- () Connect a 220 K Ω resistor (red-red-yellow) from lug 3 (S) to lug 4 (NS) of the INTEN. control L. Dress as shown in Pictorial 6.
- () Connect a 1 megohm 1 watt resistor (brown-black-green) from lug 3 (S) of FOCUS control K to the control solder lug (S) at K.
- () Connect a 470 K Ω resistor (yellow-violet-yellow) from lug 1 (S) of the FREQ. VERNIER control P to lug 12 (S) of switch S.
- () Connect either lead of a .5 μ fd 200 volt DC condenser to lug 1 (S) (use sleeving) of the SYNC. AMPLITUDE control U. Dress the condenser as shown and connect its other lead to lug 4 (S) of switch R.
- () Connect a wire from lug 3 (S) of switch R to solder lug SL2 (S).
- () Connect a wire from the control solder lug at U (NS) to SL5 (S).
- () Connect a wire from the control solder lug at U (NS) to SL6 (S).



Scan by mbravoc@wanadoo.es

PICTORIAL 6

- () Connect a 10 K Ω resistor (brown-black-orange) from lug 2 (S) (use sleeving) of switch R to lug 1 (NS) (use sleeving) of the pilot light socket PL.
- () Connect a wire from lug 10 (NS) of switch S to lug 2 (S) of control U. Dress as shown.
- () Connect a wire from lug 1 (NS) of pilot light PL to lug 8 (NS) of switch S.
- () Connect a 100 μmf disc type condenser from lug 6 (S) to lug 5 (NS) of switch S.
- () Connect a .001 μfd disc type condenser from lug 5 (S) to lug 4 (NS) of switch S.
- () Connect a .01 μfd disc type condenser from lug 4 (S) to lug 3 (NS) of switch S.
- () Connect either lead of a .1 μfd 200 volt DC condenser to the control solder lug (NS) under the SYNC. AMPLITUDE control U. Connect the other lead to lug 3 (S) of switch S.
- () Connect a 150 K Ω resistor (brown-green-yellow) from the same control solder lug (S) at U to lug 2 (NS) of switch S.
- () Connect a 10 megohm resistor (brown-black-blue) from lug 2 (S) (use sleeving) of switch S to lug 3 (NS) (use sleeving) of the PHASE control V.
- () Connect a wire from lug 1 (S) of switch S to the solder lug SL1 (S).
- () Connect a 1 K Ω resistor (brown-black-red) from solder lug SL3 (NS) to lug 1 (S) (use sleeving) of pilot light socket PL.
- () Connect a 62 Ω 5% resistor (blue-red-black-gold) from SL3 (S) to lug 2 (NS) of pilot light socket PL.
- () Connect a short piece of bare wire to lug 2 (S) of PL. Solder the other end to the frame of the pilot light socket as shown.
- () Now connect a wire from solder lug SL4 (NS) to lug 4 (S) of switch T.

CIRCUIT BOARD ASSEMBLY

The values and locations of all parts to be mounted on the circuit board are printed on the board itself for your convenience. To anyone experienced in this relatively new wiring method, this information will be self-explanatory. All parts, including five 9-pin sockets, are inserted into the board from the printed side. They are then soldered to the etched side of the board and resistor and condenser leads are then clipped to a length of about 1/8". Of course, the sockets must be rotated until the blank space between pins 1 and 9 correspond to the blank space in the metal circuit pattern.

The following method of construction has been found to be most practical and it is suggested that you proceed in this sequence.

First select the twenty-seven 1/2 watt resistor values to be installed on the circuit board and bend each lead to a 90° angle as close as possible to the resistor body. The values are as follows:

- 1 - 470 Ω (yellow-violet-brown)
- 3 - 1 K Ω (brown-black-red)
- 4 - 2.2 K Ω (red-red-red)
- 1 - 3.3 K Ω (orange-orange-red)
- 4 - 10 K Ω (brown-black-orange)
- 2 - 22 K Ω (red-red-orange)
- 2 - 47 K Ω (yellow-violet-orange)
- 3 - 100 K Ω (brown-black-yellow)
- 1 - 1 megohm (brown-black-green)
- 6 - 2.2 megohm (red-red-green)

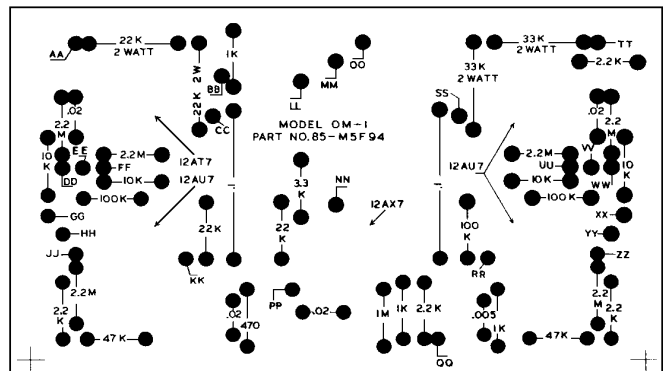

Figure 10

OM-1 CIRCUIT BOARD SCREEN 605-94

Install each resistor from the printed side of the board as shown. Make sure that the correct value is used in each position. Press each resistor in place until it lies against the circuit board itself. Turn the board over and solder each resistor lead to the metal surrounding the hole through which the lead protrudes. A small tipped iron with a rating of 25 watts to 50 watts should be used if possible. Soldering pencils are excellent. If a soldering gun is used, do not touch the tip to the circuit board until it is hot enough to solder immediately.

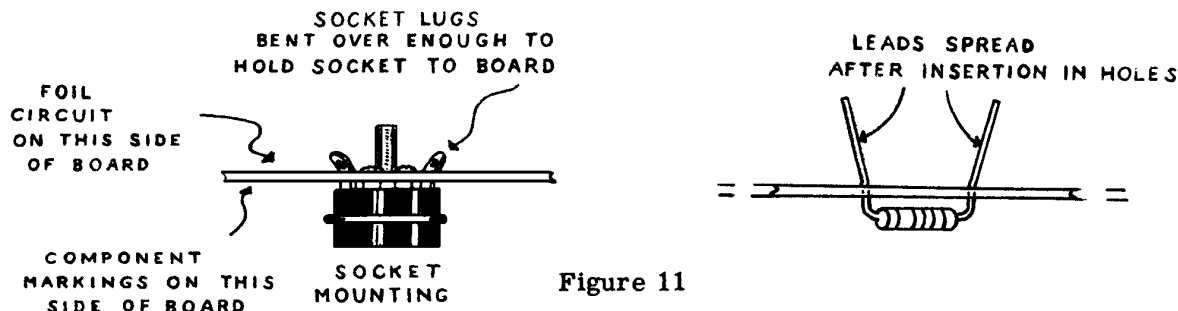

Figure 11

A convenient soldering method is to reach as many leads as you can around the edges of the board. These leads can then be clipped off short so that more leads can be reached. In this way, you will soon have all 27 resistors soldered in place.

Proceed in the same manner to install and solder the following parts:

- 2 - 22 K Ω 2 watt resistors (red-red-orange)
- 2 - 33 K Ω 2 watt resistors (orange-orange-orange)
- 4 - .02 μ fd disc type condensers
- 1 - .005 μ fd disc type condenser
- 2 - .1 μ fd 200 volt DC tubular condensers

Scan by mbravoc@wanadoo.es PICTORIAL 7

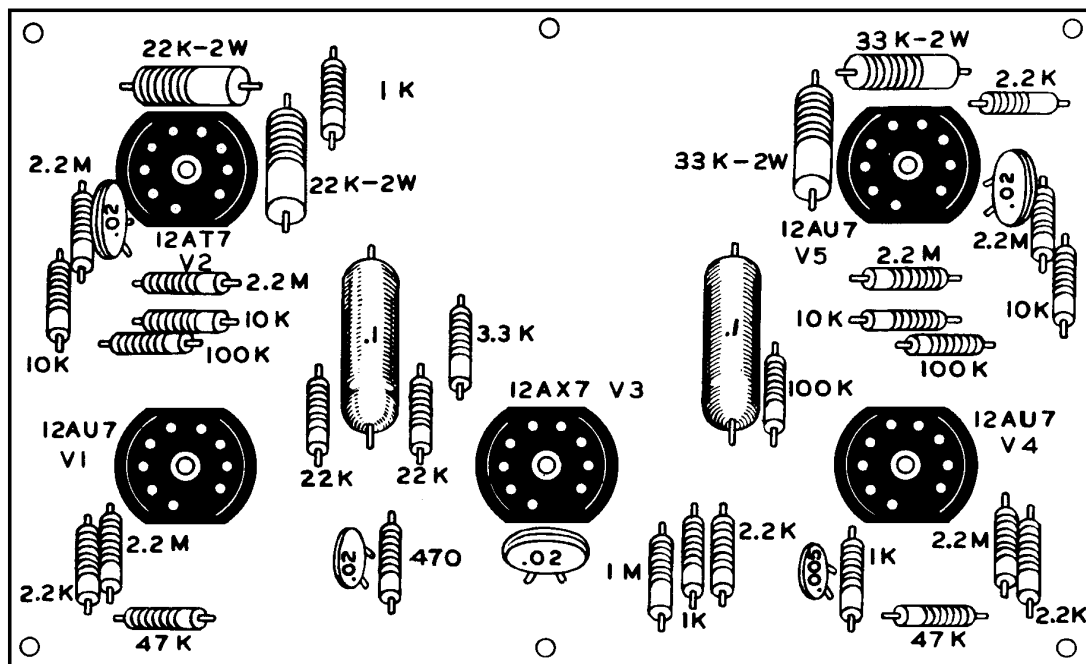

Before installing the sockets, each one should be "broken in" by inserting any 9-pin miniature tube several times. This will loosen up the pins and prevent possible damage to the circuit board through the use of heavy pressure when tubes are permanently installed.

- () Now install the five 9-pin miniature tube sockets from the printed side of the board. Rotate each one for proper orientation of the blank space between pins 1 and 9. Bend each pin (except pins 3 and 8 of V2 and V5 and pins 1 and 7 of V3) flat against its corresponding metal circuit pattern connection. Now solder the bent pins to the pattern.
- () Using short bare wires, connect pins 3 and 8 of V2, pins 3 and 8 of V5 and pins 1 and 7 of V3. Now solder the wires and the pins to the metal pattern. See Figure 12.

This completes the assembly of the circuit board.

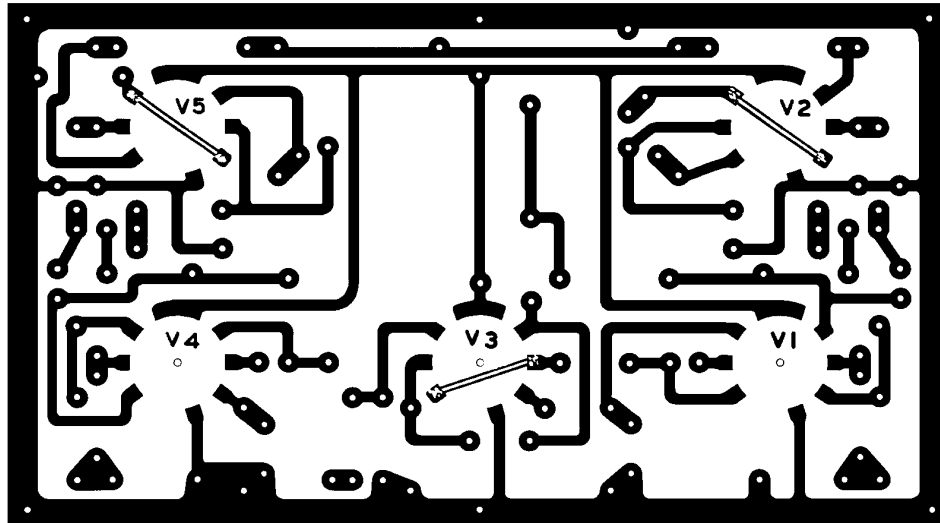
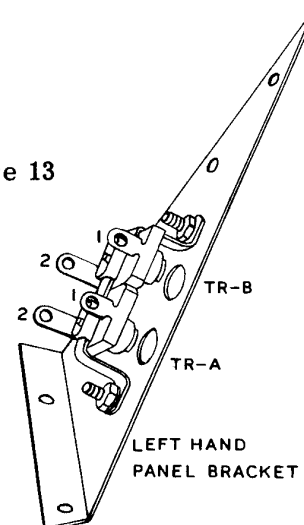

Figure 12

- () See Pictorial 9 and install the circuit board as follows: Insert 3-48 mounting screws into the board on the same side as the parts are mounted. On the other side, slip #3 lockwashers over each of the six screws. Now install the board to the top of the chassis, making sure that the lockwashers are located between the chassis and the metal foil on the board. Place a small solder lug over the screw at W and tighten all six with 3-48 nuts.
- () Now connect the chassis to the front panel by means of the left and right-hand panel brackets. Notice that the left-hand bracket has extra holes for the mounting and adjusting of the dual trimmer condenser to be installed in the next step. Use 6-32 hardware.
- () Install the dual 5-20 $\mu\mu\text{f}$ trimmer condenser on the inside of the left-hand panel bracket. The two sections are designated TR-A (nearest the panel) and TR-B. Refer to Figure 13.
- () Connect a length of bare wire from solder lug SL4 (S), through lug 1 (NS) of TR-A, to lug 1 (NS) of TR-B. See Pictorial 8.
- () Connect a 3.3 megohm 5% resistor (orange-orange-green-gold) from lug 1 (S) to lug 2 (NS) of TR-A. Allow only the clearance necessary for the trimmer screw to be turned all the way in.
- () In the same manner, install another 3.3 megohm 5% resistor between lugs 1 (S) and 2 (NS) of TR-B.

Figure 13



TO PREVENT CONFUSION, MANY OF THE PARTS AND WIRES PREVIOUSLY INSTALLED ARE OMITTED FROM THIS AND OTHER DRAWINGS.

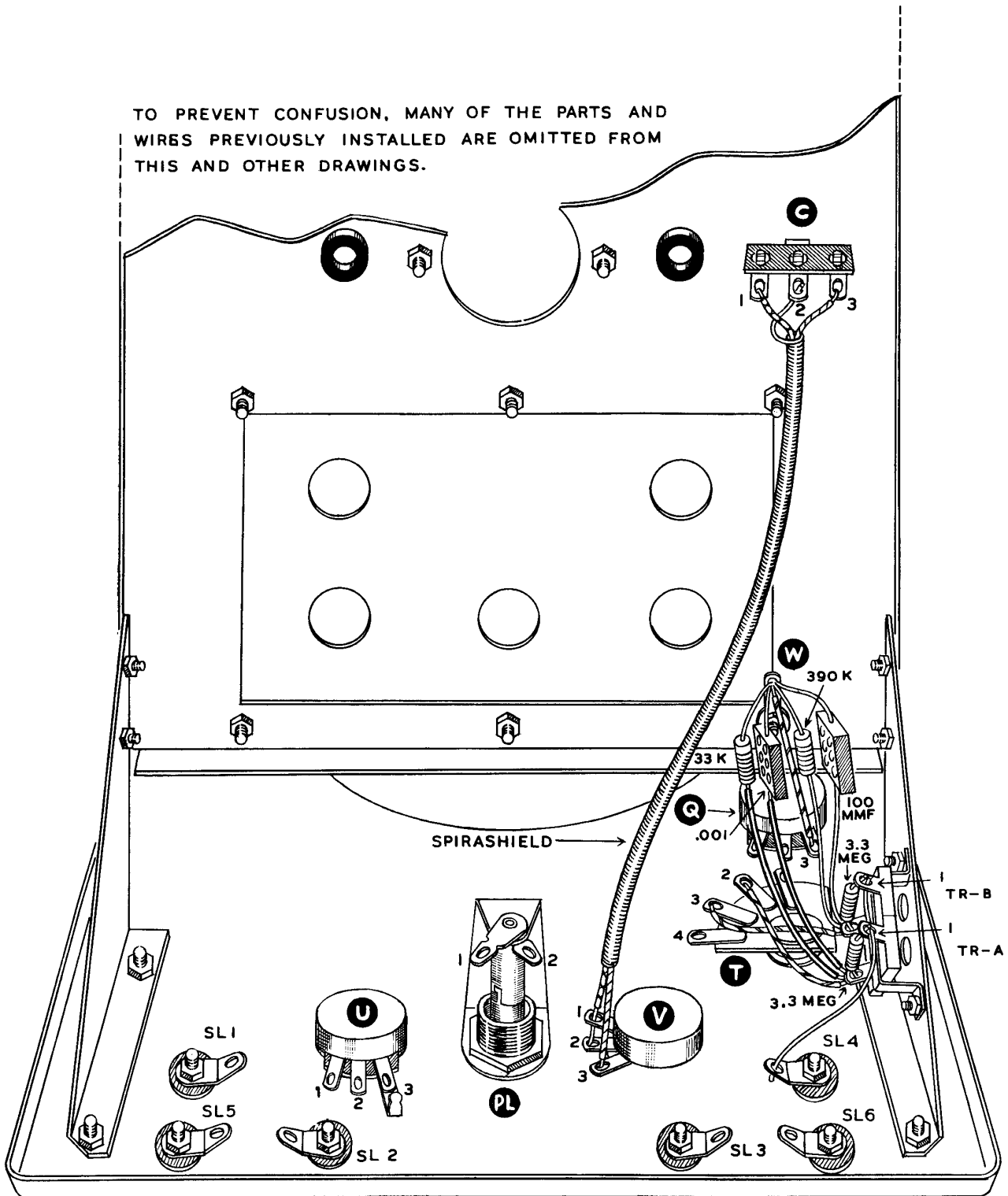

Scan by mbravoc@wanadoo.es

PICTORIAL 8

- () Connect the 100 $\mu\mu\text{f}$ mica condenser from lug 2 (NS) of TR-B to solder lug W (NS) on the chassis.
- () Connect a 390 $\text{K}\Omega$ 5% resistor (orange-white-yellow-gold) from lug 2 (NS) of TR-B to W (NS).
- () Now connect a wire from lug 2 (S) of TR-B to lug 3 (S) of panel switch T.
- () Connect another wire from lug 2 (NS) of TR-A to lug 2 (S) of switch T.
- () Connect the .001 μfd mica condenser from lug 2 (NS) (use sleeving) of TR-A to solder lug W (NS).
- () Connect a 33 $\text{K}\Omega$ 5% resistor (orange-orange-orange-gold) from lug 2 (S) (use sleeving) of TR-A to solder lug W (NS).
- () Now connect a lead from solder lug W (S) to lug 3 (S) of VERT. GAIN control Q.
- () Uncoil one end of the 6" length of spiral shielding until you have 3/4" of straight wire. Connect this wire to lug 2 (S) of terminal strip C on the chassis.
- () Strip both ends of a 7 3/4" piece of wire. Slip the wire through the spiral shield and connect one end to lug 3 (S) of terminal strip C. Connect the other end to lug 3 (S) of the PHASE control V.
- () Cut another 8 1/2" length of wire, but this time strip the insulation back about 3/4" at one end and the usual 1/4" at the other. Connect the latter end to lug 1 (S) of terminal strip C. Slip the wire through the spiral shield as before and run the lead through lug 1 to lug 2 (S) of control V. Now solder lug 1.
- () Now turn the chassis around as in Pictorial 9 on Page 20 and complete the wiring of the oscilloscope. Draw the free end of the color-coded cable between the panel and chassis and then up the right edge of the panel. Dress it around the FOCUS control K and over to the INTEN. control L.
- () Connect the yellow wire to lug 2 (S) of the INTEN. control L.
- () Connect the red wire to lug 1 (S) of control L.
- () Connect the orange wire to lug 4 (S) of control L.
- () Connect either of the white wires to lug 5 (S) of control L.
- () The remaining white wire should then be connected to lug 6 (S) of control L.
- () At the FOCUS control K, there will be two free wires coded blue and orange. Connect the orange lead to lug 1 (S) of control K.
- () Connect the blue lead to lug 2 (S) of control K.
- () Insert either lead of a .05 μfd 600 volt DC tubular condenser into the circuit board at hole JJ. Dress the condenser as shown and connect its other lead (use sleeving) to lug 1 (S) of panel switch T. Now solder and clip the lead at hole JJ in the same way that the resistors were installed.
- () Connect a wire from lug 8 (S) of switch S to the circuit board at hole NN (S). Allow enough clearance for the 12AX7 tube.

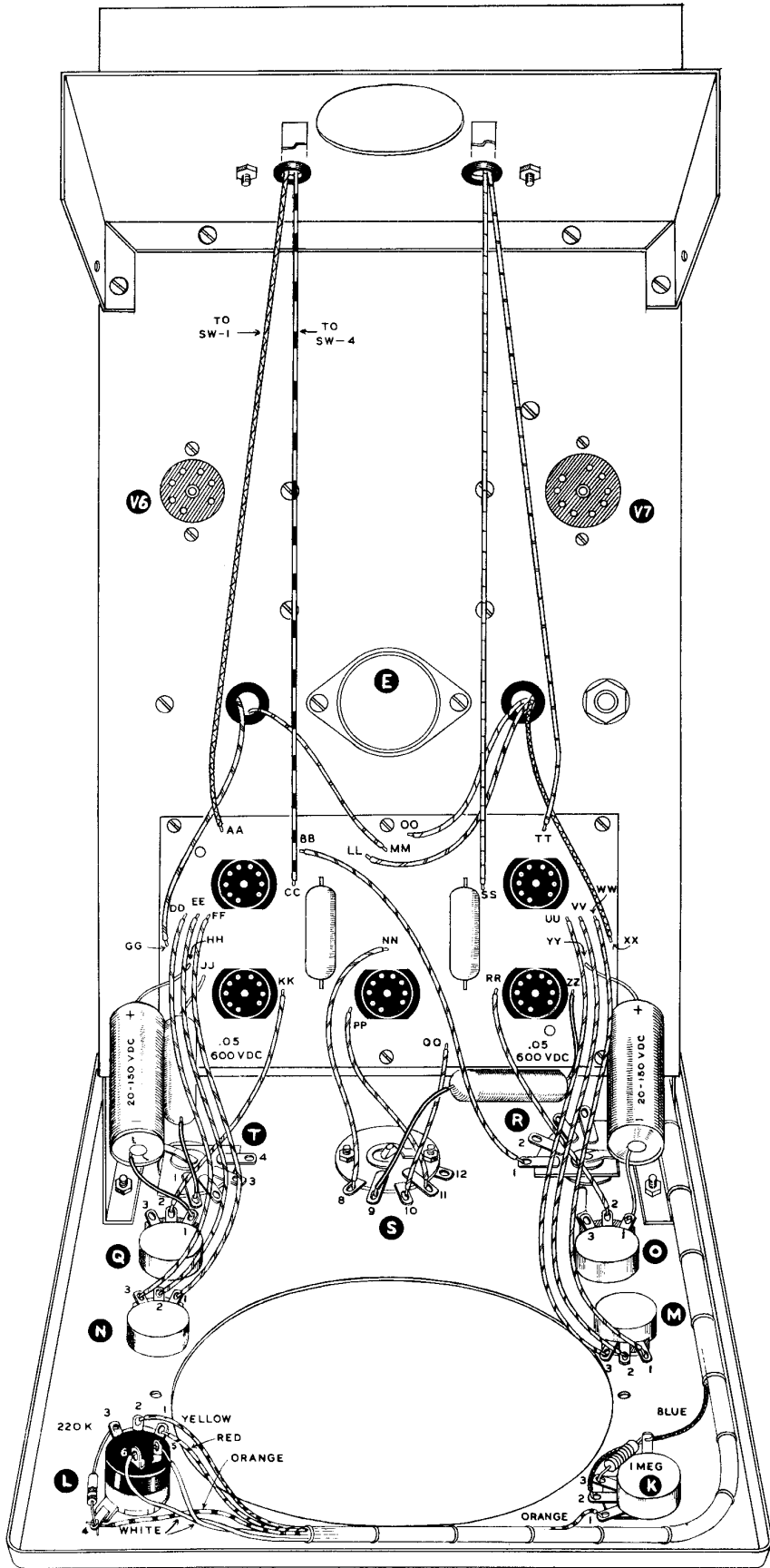

Scan by mbravoc@wanadoo.es
PICTORIAL 9

- () Connect either lead of a .05 μ fd 600 volt DC tubular condenser (use sleeving) to lug 9 (S) of switch S. Dress exactly as shown and insert the other lead (use sleeving) in the circuit board at hole ZZ and solder.
- () Connect a wire from lug 10 (S) of switch S to the circuit board hole QQ (S). CAUTION: The printing of QQ may resemble OO. Refer carefully to the pictorial so that no error will be made.
- () Connect a wire from lug 11 (S) of switch S to circuit board hole PP (S). (S11 is a double lug.)
- () Connect a wire from lug 1 (S) of switch R to circuit board hole BB (S).
- () Connect a wire from lug 2 (S) of control Q to circuit board hole KK (S).
- () Insert the positive (+) lead of a 20 μ fd 150 volt DC electrolytic condenser into the circuit board at hole HH. Dress as shown and connect the negative (-) lead (use sleeving) to lug 1 (S) of control Q. Now solder and clip the lead at HH.
- () Connect a wire from lug 2 (S) of control O to circuit board hole RR (S).
- () Insert the positive (+) lead of a 20 μ fd 150 volt DC electrolytic condenser into circuit board hole YY. Dress as shown and wire the negative (-) lead to lug 1 (S) of control O. Solder and clip the lead at YY.
- () Cut and strip both ends of three pieces of wire, each of which should be 5 3/4" long. They are used in this, and the two following steps. Connect a wire from lug 3 (S) of control N to circuit board hole DD (S).
- () Connect a wire from lug 2 (S) of control N to circuit board hole EE (S).
- () Connect a wire from lug 1 (S) of control N to circuit board hole FF (S).
- () Cut and strip three 6 3/4" wires for this step and the next two. Connect a wire from lug 3 (S) of control M to circuit board hole UU (S).
- () Connect a wire from lug 2 (S) of control M to circuit board hole VV (S).
- () Connect a wire from lug 1 (S) of control M to circuit board hole WW (S).
- () Notice now, that there are two leads protruding from the grommet located to the left of the filter condenser can. Select the lead that is connected to the ■ marked lug at filter condenser E. Connect this wire to circuit board hole GG (S).
- () The remaining lead from the same grommet (wired to lug 3 of socket V6) should then be connected to circuit board hole MM (S).
- () There are three leads protruding from the grommet on the opposite side of the filter condenser can. Connect the shortest lead from lug — of E to the circuit board hole LL (S).
- () Connect the other lead from — of E to circuit board hole XX (S).
- () The remaining lead protruding from the same grommet (wired to E ▲) should be connected to circuit board hole OO (S).
- () Refer now to the two holes in the CRT support bracket directly under the "direct input bracket." Connect the wire from lug 1 of switch SW to circuit board hole AA (S).
- () Connect the wire from lug 4 of switch SW to circuit board hole CC (S).

- () Connect the wire from lug 3 of terminal strip H to circuit board hole SS (S).
- () Connect the wire from lug 1 of terminal strip G to circuit board hole TT (S).

The wiring of your Heathkit model OM-1 Oscilloscope is now complete.

- () Install a 1V2 tube in socket V7.
- () Install a 6X4 tube in socket V6.

NOTE: When installing tubes in the sockets mounted on the circuit board, do not exert a great deal of pressure straight into the socket. This could crack the board. The tubes can be inserted quite easily by rocking them back and forth a small amount while pushing into the socket gently.

- () Refer to the markings near each socket on the board and install each of the remaining 9-pin miniature tubes in their proper places. There should be (1) 12AT7, (1) 12AX7 and (3) 12AU7.
- () Handle the 5BP1 cathode ray tube very carefully and insert it, neck first, into the panel ring from the front. The tube neck will extend through the circular opening in the CRT support bracket. When properly installed, the center of the tube face will be recessed in the ring approximately 1/4".
- () Rotate the CR tube until the keyway is straight upward and then slip the CRT socket over the pins.
- () Refer to Figure 14 and clamp the CR tube to the angle brackets mounted on the CRT support bracket. Don't forget the rubber cushion strip. The 6-32 x 1" screws are passed through the top tube clamp, the angle bracket and then the bottom tube clamp. Secure with #6 lock-washers and 6-32 nuts but do not tighten yet.
- () Apply the printed labels to the "direct input bracket" as shown.
- () Install 8-32 x 1/4" set screws in each of the twelve knobs included in the kit. Slip the four plain knobs (no index line) over the shafts of the following controls and tighten the set screws.

INTEN., FOCUS, VERTICAL CENTERING
HORIZONTAL CENTERING

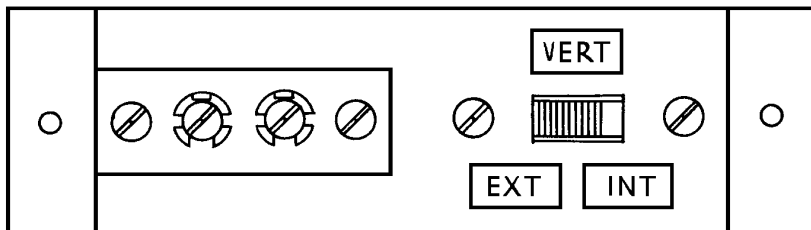

Figure 15

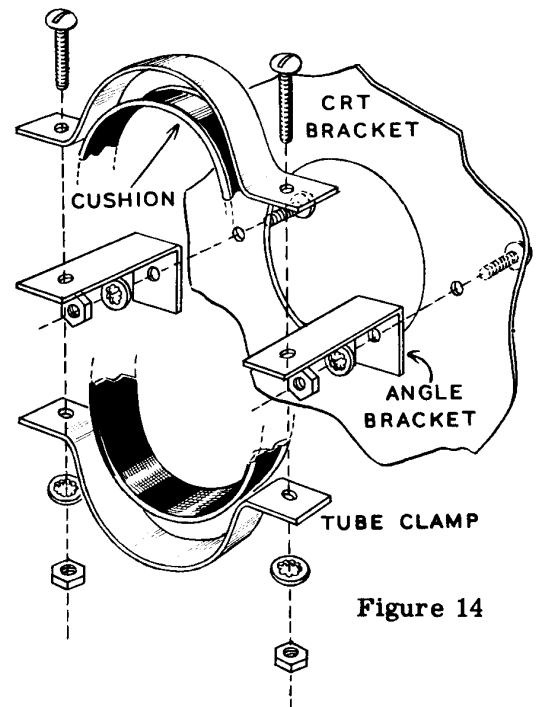

Figure 14

- () The remaining eight shafts should now be turned completely clockwise. Pliers might be required to turn the 3-position and 6-position switches. Slip knobs over all shafts and tighten the set screws with the index lines in the following positions:

VERT. GAIN - 100	SYNC. SELECTOR - INT.
HOR. GAIN - 100	HOR. SELECTOR - Line between 12 kc and 100 kc
FREQ. VERNIER - 100	SYNC. AMPLITUDE - MAX.
VERT. INPUT - X1	PHASE - Last line in clockwise direction

- () Screw black binding post caps on each of the two binding post bases marked "GND."
- () Screw red binding post caps on the remaining four binding post bases.
- () Install four rubber feet in the cabinet bottom as shown.
- () Install the cabinet handle using 10-24 screws.



Figure 16

Before proceeding to test your oscilloscope, it is recommended that the complete assembly be checked over for proper wiring and soldering. If possible, have an acquaintance double check because an error can be continually overlooked by the kit builder while it might be readily apparent to another person.

TEST AND ADJUSTMENT

DO NOT PLUG THE LINE CORD INTO AN AC OUTLET UNTIL THE FOLLOWING PARAGRAPH IS CAREFULLY READ AND CONSIDERED.

In testing and adjusting your oscilloscope, you will be exposed to very high and dangerous voltages. Some of the highest voltages will be present at the cathode ray tube socket and at the terminals of the INTEN. and FOCUS controls located behind the top rim of the panel. Do not attempt to rotate the CRT or move the scope on the workbench without first disconnecting the line cord from the AC outlet. It is suggested that you work with one hand behind your back and be sure that you are well insulated from all dampness through the use of rubber soled shoes or a dry wooden platform. These precautions may seem to be unnecessary to the experienced operator but you can be assured that momentary carelessness in the presence of high voltages or even the 60 cycle line voltage can easily be fatal.

- () Set the controls as follows before connecting the line cord to an AC outlet.
 - INTEN. - Full counterclockwise with AC switch OFF.
 - FOCUS - Approximate center of rotation.
 - VERTICAL CENTERING - Approximate center of rotation.
 - HORIZONTAL CENTERING - Approximate center of rotation.
 - VERT. GAIN - 0
 - FREQ. VERNIER - 50
 - HOR. GAIN - 0
 - VERT. INPUT - X100
 - HOR. SELECTOR - HOR. INPUT
 - SYNC. SELECTOR - INT.
 - PHASE - Approximate center of rotation.
 - SYNC. AMPLITUDE - Approximate center of rotation.
 - Astigmatism (on chassis) - Approximate center of rotation.
- () Connect the line cord to a 105-125 volt 50-60 cycle AC outlet. CAUTION: This instrument will not operate and may be seriously damaged if connected to a DC or 25 cycle AC power source or to an AC line of more than 125 volts.
- () Turn the INTEN. control fully clockwise. This will apply power to the circuit and all tubes except the 1V2 should begin to glow. This tube uses a filament voltage of less than 1 volt and a glow will be very difficult to detect. Allow at least one minute as a warm-up period.
- () As soon as a green spot appears on the face of the CR tube, reduce the intensity by rotating the INTEN. control counterclockwise. CAUTION: Do not allow a high intensity spot to remain stationary on the CRT because it can damage the fluorescent material and leave a dark spot. If no spot appears, rotate the VERTICAL and HORIZONTAL CENTERING controls simultaneously since these controls might position the spot well off the tube face. It might also be necessary to readjust the FOCUS and INTEN. controls to form a spot. Should you be unable to locate a spot at all, there is a chance that an assembly error has been made. In that case, recheck wiring and refer to the IN CASE OF DIFFICULTY section of the manual.

- () With the intensity reduced, adjust the FOCUS control for minimum spot size. There will be normal interaction between the FOCUS and INTEN. controls and by alternately adjusting each one, you can obtain a small spot of any desired intensity.
- () Center the spot in the CRT face by adjusting its vertical location with the VERTICAL CENTERING control and its horizontal location by means of the HORIZONTAL CENTERING control. Their functions are to permit centering only and not necessarily to deflect the spot off the tube face in all directions.
- () Now adjust the astigmatism control on the chassis to obtain a perfectly round spot. This control will react similarly to the FOCUS control and it might be necessary to readjust both as well as the INTEN. control to obtain a sharply defined spot. Once adjusted, however, it will be permanent unless there is a future change in the instrument's characteristics.
- () Connect a jumper wire between the 1 V. P-P and the HOR. INPUT posts. Turn the HOR. GAIN control clockwise and notice that the spot becomes a horizontal line, whose length increases as more horizontal gain is used. If the trace is not perfectly horizontal, indicate its slope with a crayon or wax pencil on the CR tube. Pull the line cord out of the AC outlet and then rotate the CR tube until the marking is level. Tighten the tube clamps and then plug the scope in again.
- () Return the HOR. GAIN control to 0 and then disconnect the jumper from the HOR. INPUT post. Connect the jumper to the VERT. INPUT post and rotate the VERT. GAIN control clockwise. A very short vertical line will develop as the control is turned the maximum amount.
- () Without touching the other controls, turn the VERT. INPUT switch to the X10 position. The line should increase in length about 10 times. Turn the switch to the X1 position and the line will fill the vertical diameter of the CRT.
- () Set the HOR. SELECTOR switch to the line between 20 and 180. Reduce VERT. GAIN for a pattern height of about 1". Adjust the HOR. GAIN control for a pattern width of about 2". Now slowly adjust the FREQ. VERNIER control to obtain a pattern consisting of three complete sine waves as in Figure 17. Stabilize the pattern by rotating the SYNC. AMPLITUDE control clockwise. A definite flickering will be noticed because the horizontal sweep frequency of 60/3 or 20 cycles per second is slow enough for the eye to detect. There may also be a random movement of the complete pattern due to slight variations in line voltage.
- () To test the PHASE control, set the HOR. SELECTOR switch to the 60 CY. position and adjust VERT. and HOR. GAIN for equal height and width. The pattern should be roughly a circle. By rotating the PHASE control from one extreme to the other, the pattern will change from a slanting line to a circle and then to an ellipse slanting in the opposite direction.
- () Pull the line cord out of the AC outlet. Disconnect the jumper between 1 V. P-P and VERT. INPUT. Connect a jumper from VERT. INPUT to the center lug of the HOR. GAIN control behind the panel. Plug the line cord in again and set the HOR. SELECTOR switch to the line between 180 and 1800. Set the FREQ. VERNIER control to 0 and the VERT. GAIN control to 100. Set the VERT. INPUT switch to X10 and adjust HOR. GAIN until the pattern resembles Figure 18A or B. Now adjust trimmer TR-B until the AB leg of the triangle disappears as in Figure 18C.
- () Move the VERT. INPUT switch to the X100 position and adjust trimmer TR-A in the same manner. Notice that this pattern will be almost horizontal and the AB leg of the triangle is much shorter.

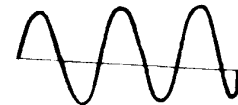

Figure 17

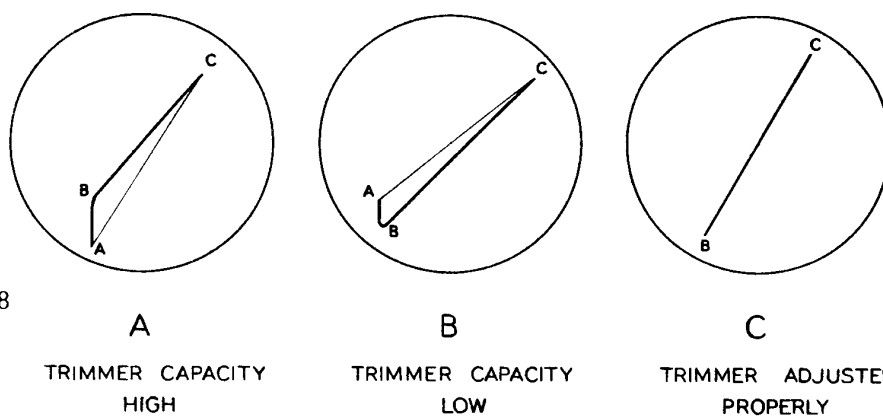

Figure 18

If all controls and switches react normally and the tests are successful, the oscilloscope can be installed in the cabinet.

- () Pass the line cord through the circular opening in the rear of the cabinet and slide the instrument in. The panel should fit snugly around the front rim. Fasten by means of two #6 sheet metal screws inserted through the rear of the cabinet into the large chassis skirt.
- () Insert another screw through the cover plate at the rear of the cabinet to hold it in place.
- () Carefully trim the green plastic grid screen to size so that it fits snugly within the felt lined panel ring. Insert the screen so that it rests against the face of the CR tube.

This completes the construction and adjustment of your Heathkit model OM-1 Oscilloscope.

IN CASE OF DIFFICULTY

If the testing procedure described does not produce the expected results, the following is recommended:

1. Check the wiring against the pictorial diagrams and closely inspect each soldered terminal. Locate each component wired to the circuit board and check their positions and values with the pictorials. If possible, have an acquaintance double check your work.
2. Check the voltages at the tube socket terminals. The readings should compare within 25% with those listed in the voltage chart. These measurements were made with a Heathkit VTVM with an input resistance of 11 megohms. Voltages may vary greatly when taken with instruments having other input characteristics. Should a serious voltage discrepancy show up, carefully check the components associated with that tube.
3. Check the tubes or have them checked at a reputable service establishment. If possible, use substitute tubes of known quality for comparison because certain types of tube defects do not show up clearly in the average emission tester.
4. If the difficulty seems to be of an intermittent nature, depending upon the physical movement of the circuit board, the metal circuit pattern should be inspected for breaks. These breaks can occur if the board has been severely bent or accidentally dropped. A broken metallic strip can easily be repaired in the following manner: Lay a piece of bare hookup wire along the strip and shape it to the original strip contours. Now solder the wire to the strip a short distance on each side of the break.
5. Should the procedure as outlined fail to correct your difficulty, write to the Heath Company describing the nature of the trouble by giving all possible details, including voltage readings obtained and other indications you may have noticed. We will try to analyze your trouble and advise you accordingly. No charge is made for this service. In all correspondence, refer to this instrument as the model OM-1 Oscilloscope.

VOLTAGE CHART

NOTE: Set all knobs as instructed for testing on Page 23, with the following exceptions:

1. Do not readjust the astigmatism control.
2. Rotate INTEN. control clockwise only until the switch clicks.

SOCKET TUBE TYPE	Pin 1	Pin 2	Pin 3	Pin 4	Pin 5	Pin 6	Pin 7	Pin 8	Pin 9
V1 12AU7	76	NS	1.8	H	H	165	32	80	0
V2 12AT7	220	6	10	H	H	220	6	10	0
V3 12AX7	108	NS	.8	H	H	125	108	108	0
V4 12AU7	125	25	60	H	H	32	NS	1	0
V5 12AU7	225	4	15	H	H	225	4	15	0
V6 6X4	300 AC	NC	H	0	NC	300 AC	350		
V7 1V2	NC	NC	NC	920 AC	920 AC	NC	NC	NC	-1050
V8 5BP1 CRT	-950	NC	225	-700	NC	220	140	225	220
	Pin 10	Pin 11							
	-1000	-970							

NS - not significant

H - heater terminal, 5.7 volt to 6.3 volt AC

NC - no connection.

Line Voltage - 115 volts at 60 cps.

No signal input.

CIRCUIT DESCRIPTION

The cathode ray tube consists of:

1. Electron Gun; which shoots a stream of electrons toward the face of the tube which is coated with a fluorescent material. This causes the tube face to light up wherever the electrons strike.
2. Control Grid; which controls the number of electrons that strike the tube and consequently the brightness of the trace. The potential on this tube element is set up by the operator by means of the INTEN. control.
3. Focusing Anode; which has the ability to converge the electron stream into a single beam of variable diameter. The FOCUS control makes it possible to reduce the size of the beam and obtain a very small spot on the tube face.
4. Accelerating Anode; which operates in conjunction with the focusing anode and speeds the electrons on their way. The potential at this element is set by means of the astigmatism control, which affects the shape rather than the size of the spot.

5. Two Vertical Deflection Plates; which are set at right angles to the direction of flow of electrons. The potential difference between the plates will bend the beam either up or down. A DC difference is set up for centering purposes by means of the VERTICAL CENTERING control.
6. Two Horizontal Deflection Plates; which operate in the same manner as the vertical plates except that their effect on the electron beam is in the horizontal direction. The HORIZONTAL CENTERING control provides the necessary centering adjustment.

To increase the overall sensitivity of the instrument, both horizontal and vertical amplifiers are used. This makes it possible to observe clearly the waveforms of voltages of very small amplitudes. For applications such as the checking of modulation percentage of an RF carrier, where the frequency response of the vertical amplifiers is inadequate, direct connection to the vertical deflection plates of the CRT are available.

A linear time base is provided by the internal sweep generator which produces a sawtooth type voltage of variable frequency. This voltage, when applied to the horizontal deflection plates, causes the spot to move at a fixed rate across the tube face from left to right. It then returns quickly to the left side to begin the next sweep. Any voltage applied to the vertical deflection plates will cause the beam to be displaced vertically at the same time. Thus the actual waveform is displayed in addition to a comparison between its repetition rate and time.

Provisions are also made so that an externally generated sweep voltage or an AC voltage at line frequency can be used in place of the built-in sweep generator.

OPERATION OF THE OSCILLOSCOPE

The operation of an oscilloscope and its many controls is quite simple once the basic principles are clear. The controls can be divided into groups with specific functions.

Two knobs marked INTEN. and FOCUS and the astigmatism control located on the chassis, control the quality of the trace. Disregarding normal interaction, the INTEN. knob adjusts brightness and the FOCUS knob the sharpness of the trace on the oscilloscope screen. The astigmatism control is permanently set by the operator for the ideal spot shape. A perfectly round spot will permit sharp focusing regardless of the direction of movement of the electron beam.

Two knobs marked VERTICAL CENTERING and HORIZONTAL CENTERING control the location of the trace on the screen. Turning the vertical knob shifts the trace up and down and the horizontal knob moves the trace left or right.

Two knobs marked VERT. INPUT and VERT. GAIN control the height of the pattern. The 3-position vertical input attenuator switch adjusts the vertical sensitivity of the oscilloscope in step functions. Fine adjustment of vertical sensitivity is made with the vertical gain control.

One knob marked HOR. GAIN control the width of the pattern.

Two knobs marked FREQ. VERNIER and HOR. SELECTOR provide the choice and the control over the sweep voltage to be applied to the horizontal deflection plates of the CRT. The maximum counterclockwise position of the horizontal frequency selector switch connects the input of the horizontal amplifiers to the HOR. INPUT binding post. This makes it possible to use an external source for the horizontal sweep voltage. The next position of the switch applies a 60 cycle sinusoidal voltage from the low voltage secondary winding of the power transformer to the input of the horizontal amplifiers, thus providing a sweep at line frequency. All other positions of the switch represent a choice, in step functions, of the frequencies available from the sawtooth sweep generator. A fine control over these frequencies is provided in the FREQ. VERNIER control.

One knob marked PHASE, controls the phase relationship between the 60 cycle line sweep voltage and any voltage that might be applied to the VERT. INPUT binding post. Its purpose is to compensate for any undesirable phase shift in the signal that you wish to observe.

Two knobs marked SYNC. SELECTOR and SYNC. AMPLITUDE provide the stabilizing action needed to keep the pattern from drifting to the left or right. With the SYNC. SELECTOR switch you can choose between (a) a synchronizing voltage taken from the signal applied to the vertical amplifiers; (b) a 60 cycle AC voltage taken from the filament winding of the power transformer and (c) any desirable synchronizing voltage that may be applied to the EXT. SYNC. binding post. In all cases, the amplitude of the required voltage is controlled by the SYNC. AMPLITUDE control.

Since each AC pattern observed on an oscilloscope will represent a peak-to-peak value, it is desirable to calibrate the grid screen so that these voltages can be accurately measured. A 1 volt peak-to-peak calibration voltage is available at the 1 V. P-P-binding post. The exact value of the calibration voltage is based on a filament supply of 6.3 volts which in turn depends upon the line voltage in a given area. Further variation from 1 volt peak-to-peak may occur due to the normal tolerances allowed in the voltage divider resistance values. Knowing all of these variables, any one oscilloscope can be accurately adjusted to measure peak-to-peak voltages with good accuracy.

In order to couple a signal directly to the vertical plates of the CRT, the DPDT switch at the rear of the oscilloscope must be moved to the EXT. position. The signal is then applied across the terminals of the 2-screw strip located next to the switch. Polarity is not important because neither of the vertical deflection plates are grounded within the scope itself. The sensitivity of the cathode ray tube and the amplitude of the applied signal will determine the height of the pattern.

For the safety of the operator, B+ potential is blocked from the 2-screw terminal strip by the two .005 μ fd disc type condensers. They also serve to maintain the use of the VERTICAL CENTERING control by preventing the virtual shorting of the vertical deflection plates through a low impedance signal source. The VERT. GAIN control however, will have no effect. In all oscilloscope applications requiring the use of vertical amplifiers, the DPDT switch should be in the INT. position.

REPLACEMENTS

Material supplied with Heathkits has been carefully selected to meet design requirements and ordinarily will fulfill its function without difficulty. Occasionally improper instrument operation can be traced to a faulty tube or component. Should inspection reveal the necessity for replacement, write to the Heath Company and supply all of the following information:

- A. Thoroughly identify the part in question by using the part number and description found in the manual parts list.
- B. Identify the type and model number of kit in which it is used.
- C. Mention the order number and date of purchase.
- D. Describe the nature of defect or reason for requesting replacement.

The Heath Company will promptly supply the necessary replacement. Please do not return the original component until specifically requested to do so. Do not dismantle the component in question as this will void the guarantee. If tubes are to be returned, pack them carefully to prevent breakage in shipment as broken tubes are not eligible for replacement. This replacement policy does not cover the free replacement of parts that may have been broken or damaged through carelessness on the part of the kit builder.

If the circuit board has been accidentally damaged through breakage, the excessive use of solder, through the use of acid or paste fluxes or for any other reason, a complete repair kit is available. The Heathkit Repair Kit R-OM1 for the OM-1 Oscilloscope will consist of etched circuit board and all sockets, resistors and condensers to be mounted directly on the board itself. The price is \$5.00 plus postage. A replacement for the horizontal selector switch is available as a separate item for \$.75 plus postage.

SERVICE

In event continued operational difficulties of the completed instrument are experienced, the facilities of the Heath Company Service Department are at your disposal. Your instrument may be returned for inspection and repair for a service charge of \$5.00 plus the cost of any additional material that may be required. **THIS SERVICE POLICY APPLIES ONLY TO COMPLETED INSTRUMENTS CONSTRUCTED IN ACCORDANCE WITH THE INSTRUCTIONS AS STATED IN THE MANUAL.** Instruments that are not entirely completed or instruments that are modified in design will not be accepted for repair. Instruments showing evidence of acid core solder or paste fluxes will be returned not repaired.

The Heath Company is willing to offer its full cooperation to assist you in obtaining the specified performance level in your instrument. Factory repair service is available for a period of one year from the date of purchase or you may contact the Engineering Consultation Department by mail. For information regarding the possible modification of existing kits, the volumes listed in the Bibliography section are recommended. They can be obtained at or through your local library, as well as at any electronic outlet store. Although the Heath Company sincerely welcomes all comments and suggestions, it would be impossible to design, test, evaluate and assume responsibility for proposed circuit changes for specific purposes. Therefore, such modifications must be made at the discretion of the kit builder according to information which will be much more readily available from some local source.

SHIPPING INSTRUCTIONS

Before returning a unit for service, be sure that all parts are securely mounted. Attach a tag to the instrument giving name, address and trouble experienced. Pack in a rugged container, preferably wood, using at least three inches of shredded newspaper or excelsior on all sides. **DO NOT SHIP IN THE ORIGINAL KIT CARTON AS THIS CARTON IS NOT CONSIDERED ADEQUATE FOR SAFE SHIPMENT OF THE COMPLETED INSTRUMENT.** Ship by prepaid express if possible. Return shipment will be made by express collect. Note that a carrier cannot be held liable for damage in transit if packing, in HIS OPINION, is insufficient.

SPECIFICATIONS

All prices are subject to change without notice. The Heath Company reserves the right to discontinue instruments and to change specifications at any time without incurring any obligation to incorporate new features in instruments previously sold.

WARRANTY

The Heath Company limits its warranty of parts supplied with any kit to a period of three (3) months from the date of purchase. Replacement will be made only when said part is returned postpaid, with prior permission and in the judgment of the Heath Company was defective at the time of sale. This warranty does not extend to any Heathkits which have been subjected to misuse, neglect, accident and improper installation or applications. Material supplied with a kit shall not be considered as defective, even though not in exact accordance with specifications, if it substantially fulfills performance requirements. This warranty is not transferable and applies only to the original purchaser. This warranty is in lieu of all other warranties and the Heath Company neither assumes nor authorizes any other person to assume for them any other liability in connection with the sale of Heathkits.

The assembler is urged to follow the instructions exactly as provided. The Heath Company assumes no responsibility or liability for any damages or injuries sustained in the assembly of the device or in the operation of the completed instrument.

HEATH COMPANY
Benton Harbor, Michigan

SOME OSCILLOSCOPE APPLICATIONS

As mentioned in the introduction to this manual, the cathode ray oscilloscope is a most versatile device. It has the ability to measure the basic electrical quantities and more important, to show the relationship between any two of these quantities at any one time. Or, it can relate any one of the variables against a controlled time reference. Therefore, it can indicate such characteristics as frequency, phase relations and waveform.

By use of supplementary devices called transducers, a great variety of other physical attributes can be investigated with the oscilloscope. These transducers are used to convert sound, heat, light, stress or physical movement into electrical impulses. The impulses can be studied by displaying them on the screen of the oscilloscope.

The following portion of this manual is simply to familiarize you with the basic applications of your oscilloscope. Each one of the uses described is well within the capabilities of the Heathkit model OM-1 Oscilloscope.

Waveform Investigation: Probably the major use of most oscilloscopes is in the study of recurrent or transient variations in an electrical quantity. Since the oscilloscope is a voltage operated device, these variations must be first converted into changes in voltage.

It is common practice to apply the signal voltage to the vertical input to the oscilloscope. By the use of amplifiers, this voltage is made to displace vertically the electron beam in the cathode ray tube. At the same time, the beam is being swept horizontally by the sweep generator within the instrument. The sweep frequency is normally a sub-harmonic or simple fraction of the signal frequency. Therefore, more than one complete cycle of the signal is shown in the screen.

With this brief background, we have described below the more common applications of the oscilloscope in studying waveform.

Testing Audio Amplifiers and Circuits: Figure 19 shows the conventional set-up of equipment for this application. The audio generator should be capable of producing a pure sine wave with a very low harmonic distortion. The load resistor should match the output impedance of the amplifier. The usual practice is to perform all tests at an input voltage sufficient only to develop a reference power output. This prevents overloading of any portion of the amplifier and consequent inaccuracies in measurements.

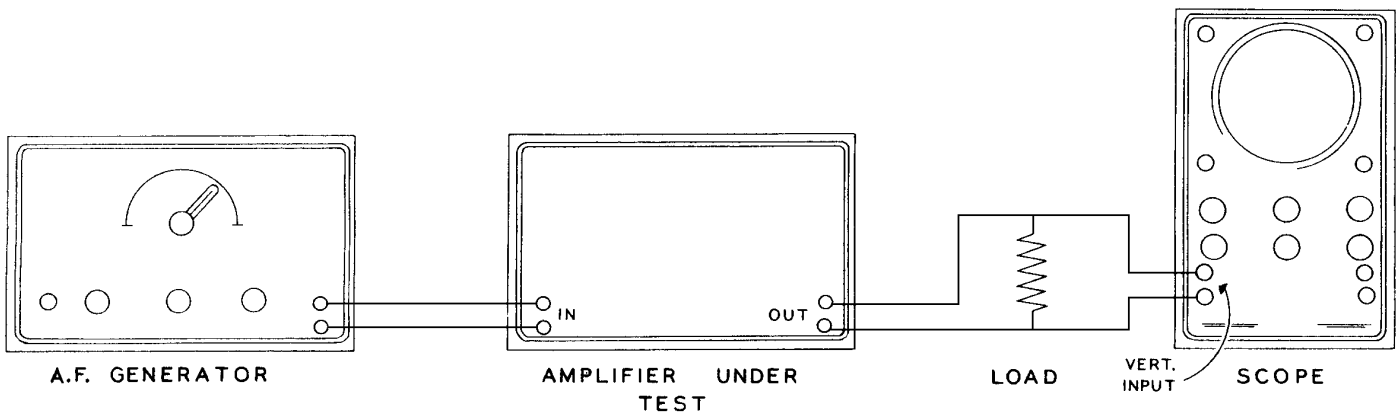

Figure 19

Figure 20A shows serious flattening of one peak representing about 10% harmonic distortion. This condition may be caused by incorrect bias on any stage or by an inoperative tube in a push-pull stage. Figure 20B indicates third harmonic distortion, a particularly objectionable fault. Figure 20C shows flattening of both peaks, usually an indication of overload somewhere in the circuit.

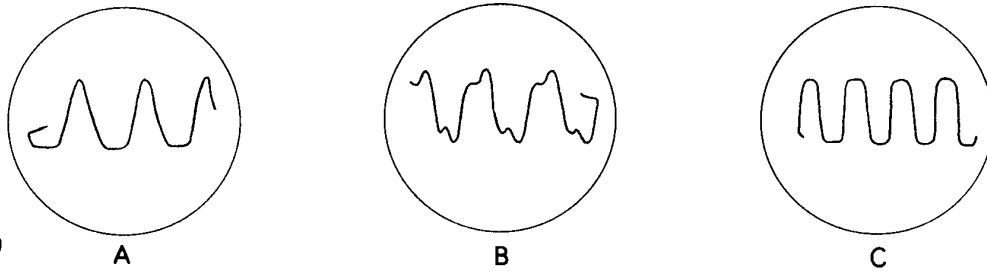

Figure 20

Although the use of sine wave input tells us a lot about an amplifier, the use of a square wave input waveform gives a very accurate and extremely sensitive indication of the performance of the system with respect to both amplitude distortion and phase shift. Assume that we apply a wave of the form shown in Figure 21A with a fundamental frequency of 60 cycles. In a theoretically perfect amplifier, the output waveform would be an exact duplicate except at a greater power level as determined by the gain of the amplifier. Actually, the distortion of this waveform as shown in the scope tells a great deal about the amplifier at frequencies considerably separated from the test frequency. If the high frequency performance of the amplifier is excellent, the front of the waveform will be sharp cornered and clean.

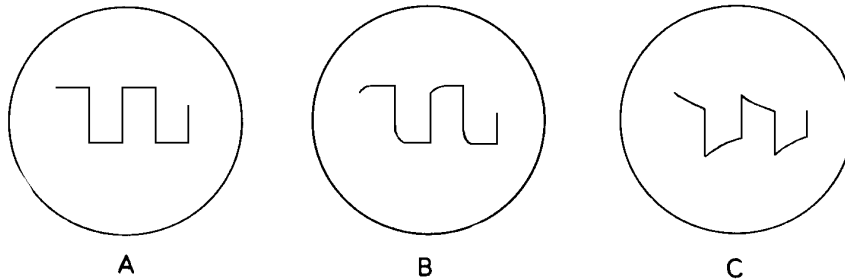

Figure 21

A distortion similar to that shown in Figure 21B indicates a poor high frequency response, which may be amplitude distortion, phase shift, or both. We may assume therefore, that the shape of the rising portion of the waveform indicates the ability of the amplifier to faithfully reproduce high frequencies. Conversely, the slope of the flat top portion of the wave, indicates the performance of the amplifier in the low frequency range. Figure 21C is the characteristic indication of an amplifier with a poor low frequency response.

Again, the square wave generator used must be capable of producing the desired waveform with excellent voltage regulation and low inherent distortion. The Heathkit model AO-1 Audio Oscillator is recommended.

Further discussion of this method is beyond the scope of this manual. Interested readers are referred to the bibliography for further sources.

Servicing Television Receivers: Servicing of television receivers is a rapidly expanding application of the cathode ray oscilloscope. Each of the following basic uses require some additional equipment, but none of them can be performed without using the oscilloscope.

Alignment of a television receiver is virtually impossible without the use of an oscilloscope and a television alignment sweep generator such as the Heathkit TS series. This type of generator supplies an RF signal over all the frequencies involved in modern television receiver operation. The signal can be frequency modulated at 60 cycles per second with a deviation of several megacycles. The generator also provides a 60 cycle sweep voltage controllable in phase to drive the horizontal deflection amplifiers in the oscilloscope. It also provides a blanking system which cuts off the RF output of the generator during one-half of its operating cycle. In effect, the generator output starts at a reference frequency and sweeps alternately at a uniform rate from reference frequency to frequencies several megacycles above and below. Vertical input to the scope is driven by voltage developed at the input of the video amplifier. Since this voltage varies in exact accordance with the gain of the RF and/or IF amplifier stages over the frequency range being swept, the trace on the screen is actually a graphic representation of the response of the amplifiers being tested.

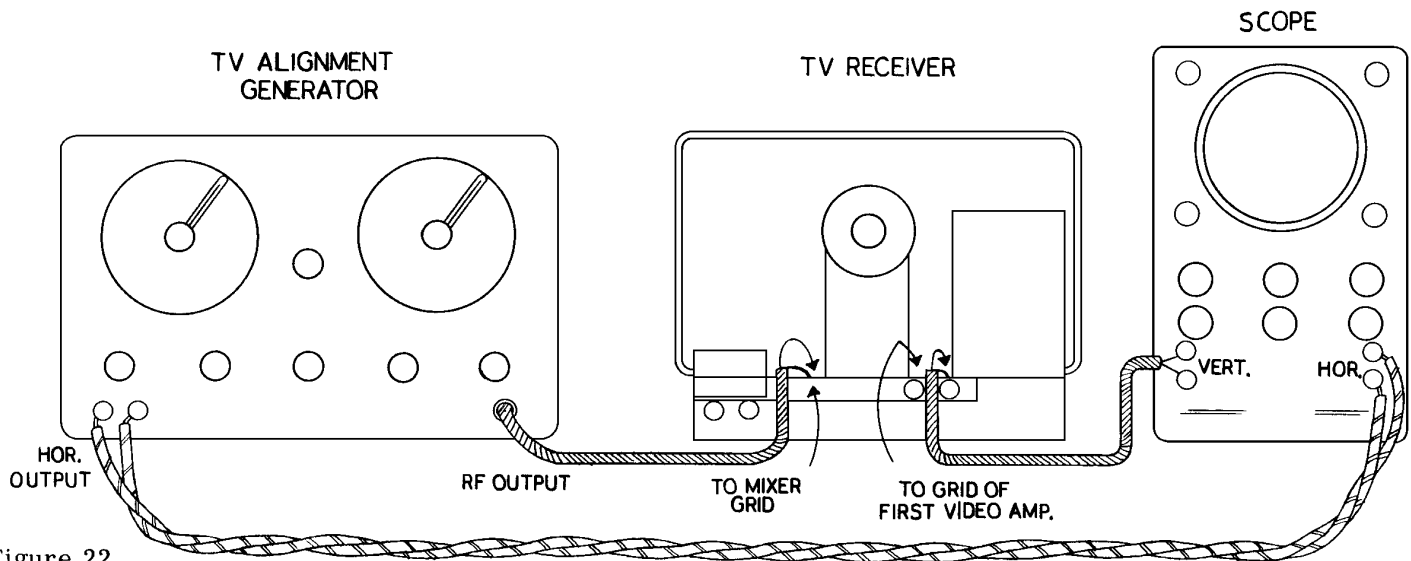

Figure 22

Figure 22 outlines the connections between alignment generator, receiver and oscilloscope. The exact procedure for alignment varies greatly. This information is generally available in the manufacturers' service information. Usually a drawing of the desired response curve is given together with a sequence of adjustments to roughly approach the desired pattern. Final adjustments are made while watching the trace on the oscilloscope.

The waveform of the complex television picture signal as it is passed through the receiver is undoubtedly the most important characteristic of the signal voltage. In order to properly display the minute variations in waveform which incidentally make up the difference between good and bad picture quality, the oscilloscope is required to amplify and display voltage changes over an extremely wide frequency range without distorting them.

Again, you must rely on the manufacturer to furnish representative patterns showing the waveform to be expected at specific points within the receiver. You will find that these diagrams cover the entire receiver with the exception of the front end or tuner portion. However, in order to pick off the modulation envelope in the IF or video amplifier sections, a demodulator probe is used to make connections to the plate, grid or cathode of the stage being investigated. This is necessary since the signal in these stages is still contained in the amplitude modulation envelope of the carrier and must be detected or demodulated before it can be shown on the oscilloscope.

The Heathkit Demodulator Probe is designed for this purpose. At any point after the video detector, no such probe is necessary and a simple shielded low capacity cable can be used.

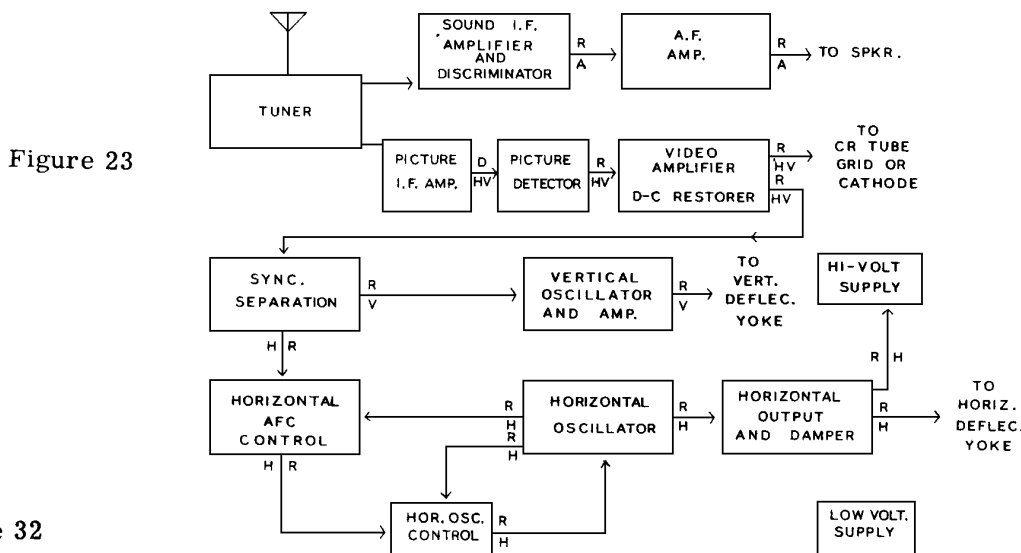

Figure 23

OPERATE OSCILLOSCOPE AS SHOWN BELOW:

- R Use direct input.
- D Use demodulated input.
- H Use 7,875 or 15,750 cps sweep.
- V Use 20, 30 or 60 cps sweep.
- A Use audio test frequency sweep or half this frequency.

NOTE: For simplicity, all amplifier stages are shown within one block in the diagram. Tests may be made at the input or output of individual amplifier stages using the indicated mode of operation.

In either case, the signal voltage is fed into the vertical amplifier of the oscilloscope as shown in Figure 23. At any point up the video detector, the voltages picked off will be quite small and considerable vertical gain will be required. Within the sync circuits and deflection circuits, however, these voltages reach very respectable proportions and very little amplification is required.

In checking waveform, remember that two basic frequencies are involved in the television signal. The vertical or field frequency is 60 cycles per second. Any investigation of the circuit except within the horizontal oscillator, its differentiator network and the horizontal amplifier stages can generally be made using a sweep generator frequency of 20 to 30 cycles, thus showing two or three complete fields of the signal. In order to study the horizontal pulse shape or the operation of the horizontal deflection system, it is generally necessary to operate the sweep generator at 15,750 or 7,875 cycles per second. This sweep rate will show the waveform of one or two complete lines of the signal.

The signal tracing method of analysis is most helpful in going through a receiver in this fashion, since faulty receiver operation is generally caused by the loss of all or a significant portion of the picture information and pulses at some stage within the receiver. With a basic understanding of the function of each part of the signal and with the means available to determine what the signal actually looks like at any part of this receiver, it is a comparatively simple matter to isolate the defective portion and the particular component causing the failure.

Remember in making connections to the test points that grid circuits are generally high impedance points and that the addition of any capacity can disrupt the performance of the stage to some degree. Plate circuits and cathode circuits are usually lower impedance points and more desirable for testing purposes. Also bear in mind that the plate circuit indication with respect to polarity will be exactly opposite to indications obtained on grid or cathode, since a phase difference of 180° takes place within the tube. Therefore, the pattern shown on the scope screen may be inverted when such interchanges are made. The form of the wave will not be changed however.

Video amplifier response can be measured in exactly the same manner described for testing audio amplifiers and again a square wave signal is the most efficient method to use. Because a video amplifier must pass signals as low as 20 cycles and as high as 4 or 5 megacycles, a more comprehensive test is required. Usually a 60 cycle check is made to cover low and medium frequency characteristics. A second check at 25kc covers the high frequency portion of the response curve. Again such tests require accuracy on the part of the oscilloscope. The signal tracing technique can be used in these tests also. The square wave generator is fed directly into the first video amplifier grid. Very low signal input will be required. Then the oscilloscope is connected to various plates starting near the output end and working back until any distortion is isolated. Patterns such as Figure 21B are responsible for poor picture detail or fuzziness, while distortion of the waveform shown in Figure 21C can cause shading of the picture from top to bottom.

Observing Modulation Patterns: Amateur radio operators often use the oscilloscope to check the quality of modulated RF signals obtained from their transmitters. Since the vertical amplifier frequency response of the oscilloscope is not adequate to accurately reproduce the frequencies of the RF carrier, direct connections to the vertical deflection plates of the cathode ray tube are required. These connections are available at the rear of the Heathkit OM-1 Oscilloscope.

When using the oscilloscope for this purpose, the operator generally relies on the trapezoidal pattern for test purposes. Such a pattern is formed when a modified RF signal is applied to the vertical deflection plates of the cathode ray tube and the modulating audio signal used for horizontal deflection. This modulating signal can be applied to the horizontal input terminals of the oscilloscope.

The appearance of a typical trapezoidal pattern is given in Figure 24A. As the modulation percentage increases, the pattern becomes more triangular in shape, approaching a perfect triangle with 100% modulation as shown in Figure 24B. Over modulation gives patterns shown in Figure 24C.

Figure 24

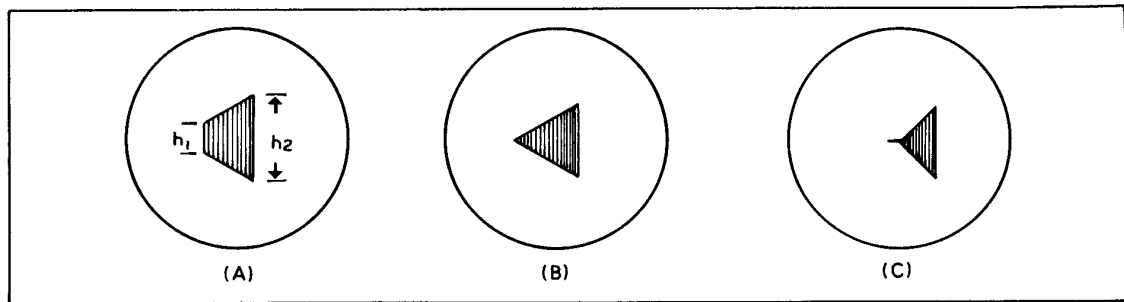

A trapezoidal pattern is useful for determining percentage modulation. The maximum (h_2) and minimum (h_1) heights of the trapezoid are measured using any convenient unit. Percentage of modulation may then be calculated as follows:

$$\frac{(h_2 - h_1)}{(h_2 + h_1)} \times 100 = \text{Percentage modulation}$$

Trapezoidal patterns are also useful for indicating the operational characteristics of RF signals obtained from carrier current transmitters, phono oscillators and similar devices. Typical patterns that may be obtained are shown in Figure 25.

Figure 25

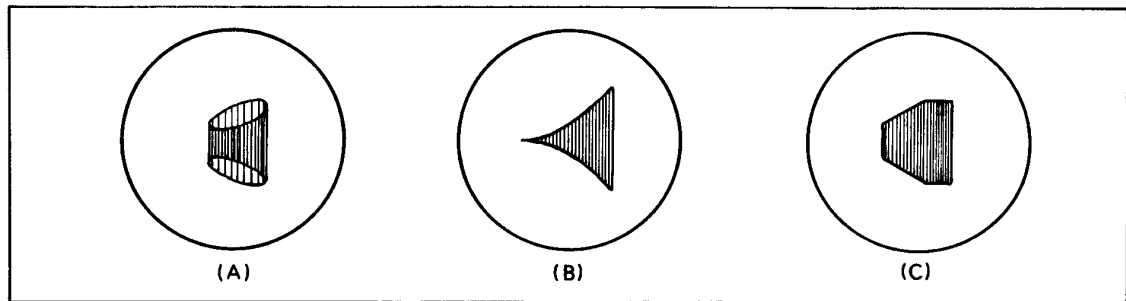

Figure 25A shows the type of pattern obtained with less than 100% modulation, but with phase shift in the audio signal between the point at which the audio signal is taken for the oscilloscope horizontal deflection and the point at which carrier modulation occurs. Such a pattern corresponds essentially to the pattern given in Figure 24A. It does not indicate a defect or improper operation.

Figure 25B gives the type of pattern obtained where an improperly operated Class C, RF amplifier is used. Such a pattern may be caused by regeneration, improper neutralization or excessive bias.

The pattern shown in Figure 25C may be caused by insufficient RF grid drive to a modulated amplifier or a weak amplifier tube. Saturation is reached on the modulated peaks, resulting in the flattened appearance.

Miscellaneous Waveform Measurements: In this category, we can place such waveform investigations as studies of noise and vibration, sub-sonic and super-sonic applications and hundreds of others. Each of these fields is highly specialized and it is obviously impossible to cover them here. We again refer you to the bibliography for further reading in this field.

AC Voltage Measurements: Because of its peculiar characteristics, the oscilloscope is particularly suited to the measurement of AC voltages. With the advent of television, it has become imperative that such measurements be made accurately without respect to wave shape, so that the conventional RMS reading AC voltmeter is no longer adequate. Most television service bulletins specify peak-to-peak voltages which appear at various points of the circuit. Other applications for such measurements are becoming more common every day.

The OM-1 can be used to accurately measure and display these voltages. It can be calibrated by any one of many methods for this purpose.

When using the oscilloscope for AC voltage measurement, it is sometimes helpful to use the horizontal input setting for the horizontal selector switch. This produces a vertical line which can be focused and centered exactly for most accurate readings.

The following relationships exist between sine wave AC voltages:

$$\text{RMS} \times 1.414 = \text{Peak Voltage}$$

$$\text{RMS} \times 2.828 = \text{Peak-to-Peak Voltage}$$

$$\text{Peak Voltage} \times 0.707 = \text{RMS Voltage}$$

$$\text{Peak-to-Peak Voltage} \times 0.3535 = \text{RMS Voltage}$$

AC Current Measurements: To measure AC currents, the unknown current must be passed through a resistor of known value. The voltage drop across this resistor is measured as described above. From Ohm's Law, $I = \frac{E}{R}$ the current can be calculated. It is important that the resistor be non-reactive at the frequency involved. It should also be relatively small with respect to the resistance of the load.

Frequency Measurements: Frequency measurements can be made with an accuracy limited only by the reference frequency source available. In most cases, this can be the 60 cycle line frequency which is usually controlled very closely. The unknown frequency is applied to the vertical input and the reference frequency to the horizontal input. The internal sweep generator is not used. The resultant pattern may take on any one of a number of shapes. Typical patterns are shown below.

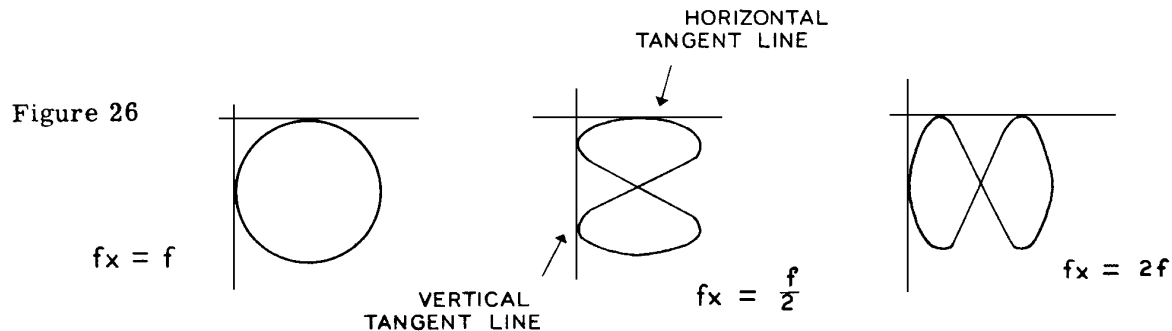

The frequency ratio can be calculated from the formula, $f_x = \frac{Th \times f}{Tv}$ where f_x is the unknown frequency; Th is the number of loops which touch the horizontal tangent line; Tv is the number of loops which touch the vertical tangent line.

When using Lissajous figures as these curves represent, it is good practice to have the figure rotating slowly rather than stationary. This eliminates the possibility of an error in counting the tangent points. If the pattern is stationary, a double image may be formed. In such cases, the end of the trace should be counted as one-half a tangent point rather than a full point. This condition may occur when neither frequency can be varied.

Phase Measurements: It is sometimes necessary to determine the phase relationship between two AC voltages of the same frequency. This can be accomplished quite easily by applying one of the voltages to the horizontal input and the other voltage to the vertical input. The phase relationship can be estimated from the figures below.

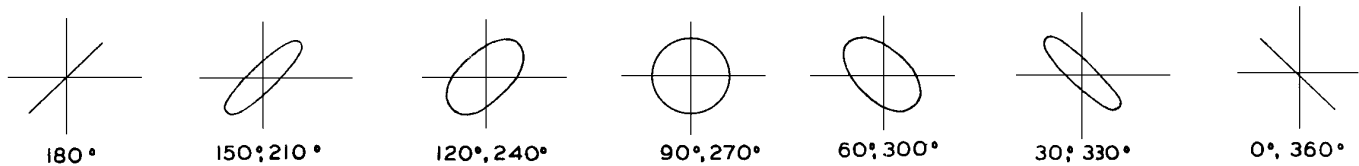

Figure 27

To calculate the phase relationship, use the following formula: $\sin \phi = \frac{A}{B}$

The distance A is measured from the X axis to the intercept point of the trace and the Y axis. The distance B represents the height of the pattern above the X axis. The axis of the ellipse must pass through the point O.

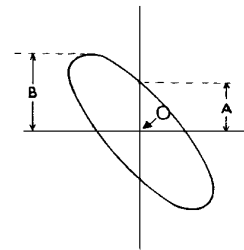

Figure 28

BIBLIOGRAPHY

While many issues of the popular radio and service magazines have carried excellent articles on the construction and application of oscilloscopes and their reading is highly recommended, we also suggest the following excellent books:

- Ruiter; Modern Oscilloscopes and Their Uses
- Sylvania; How to Service Radios With an Oscilloscope
- Hickok; How to Use the CR Oscilloscope in Servicing Radio and TV
- Rider; The Cathode Ray Tube at Work
- Turner; Radio Test Instruments
- Editors and Engineers; Radio Handbook
- A. R. R. L. ; Radio Amateurs' Handbook
- Rider and Uslan; Encyclopedia on Cathode Ray Oscilloscopes and Their Uses

<u>PART No.</u>	<u>PARTS Per Kit</u>	<u>DESCRIPTION</u>
-----------------	----------------------	--------------------

Resistors

1-6	1	470 Ω
1-9	4	1 KΩ
1-44	4	2.2 KΩ
1-14	1	3.3 KΩ
1-20	5	10 KΩ
1-22	2	22 KΩ
1-25	2	47 KΩ
1-26	4	100 KΩ
1-27	1	150 KΩ
1-29	1	220 KΩ
1-33	1	470 KΩ
1-35	3	1 megohm
1-37	6	2.2 megohm
1-40	1	10 megohm
1-84	1	62 Ω 5%
1-76	1	33 KΩ 5%
1-77	1	390 KΩ 5%
1-78	2	3.3 megohm 5%
1-7A	1	47 KΩ 1 watt
1-34A	1	1 megohm 1 watt
1-15B	1	1 KΩ 2 watt
1-11B	3	22 KΩ 2 watt
1-18B	2	33 KΩ 2 watt

Condensers

20-11	1	100 μmf mica
20-33	1	.001 μfd mica
21-9	1	100 μmf Discap
21-14	1	.001 μfd Discap
21-27	3	.005 μfd Discap
21-16	1	.01 μfd Discap
21-31	4	.02 μfd Discap
23-60	1	.01 μfd 1600 v tubular
23-10	2	.05 μfd 600 v tubular
23-28	3	.1 μfd 200 v tubular
23-62	1	.1 μfd 1600 v tubular
23-30	1	.2 μfd 1200 v tubular
23-56	1	.5 μfd 200 v tubular
25-19	2	20 μfd 150 v elec.
25-21	1	20-20-20-20 μfd 450 v elec.
31-11	1	Dual 5-20 μmf trimmer

Controls-Switches

10-8	2	10 KΩ control
10-11	2	50 KΩ control
19-25	1	50 KΩ control w/SPST switch
10-12	1	100 KΩ control
10-14	1	250 KΩ control
10-32	2	1 megohm control
10-45	1	7500 KΩ control
60-2	1	DPDT slide switch
63-47	2	3-position rotary switch
63-83	1	6-position rotary switch

<u>PART No.</u>	<u>PARTS Per Kit</u>	<u>DESCRIPTION</u>
-----------------	----------------------	--------------------

Tubes-Lamps

411-1	1	5BP1 CR tube
411-24	1	12AT7 tube
411-25	3	12AU7 tube
411-26	1	12AX7 tube
411-64	1	6X4 tube
411-65	1	1V2 tube
412-1	1	#47 pilot lamp

Wire

100-52	1	Cable
340-2	1	length Bare wire
344-1	1	length Hookup wire
346-1	2	length Sleeving
89-1	1	Line cord
206-30	1	length Spirashield

Sockets-Terminal Strips

434-15	1	7-pin tube socket
434-16	1	9-pin tube socket
434-46	5	9-pin tube socket
434-48	1	11-pin CRT socket
434-22	1	Pilot light socket
431-2	1	2-lug terminal strip
431-3	2	3-lug terminal strip
431-5	1	4-lug terminal strip
431-10	1	3-lug terminal strip
431-6	1	2-screw terminal strip

Hardware

250-2	10	3-48 x 1/4 screw
250-8	5	#6 x 3/8 sheet metal screw
250-9	26	6-32 x 3/8 screw
250-13	2	6-32 x 1 screw
250-17	4	8-32 x 1/4 screw
250-19	2	10-24 x 3/8 screw
250-43	12	8-32 x 1/4 set screw
252-1	10	3-48 hex nut
252-3	34	6-32 hex nut
252-4	4	8-32 hex nut
252-7	13	Control nut
252-12	1	Pilot light nut
253-10	13	Control washer
254-1	29	#6 lockwasher
254-2	4	#8 lockwasher
254-4	8	Control lockwasher
259-1	7	#6 solder lug
259-6	1	Solder lug, small
259-10	5	Control solder lug
254-7	6	#3 lockwasher
75-17	12	Insulator bushing

<u>PART</u> <u>No.</u>	<u>PARTS</u> <u>Per Kit</u>	<u>DESCRIPTION</u>
Knobs-Terminals		
100-M16B	2	Binding post cap, black
100-M16R	4	Binding post cap, red
427-2	6	Binding post base
462-18	4	Knob, narrow skirt
462-19	8	Knob, indexed
Sheet Metal Parts		
90-34	1	Cabinet
200-M75	1	Chassis
203-68F91	1	Panel
204-M68	2	Angle bracket
204-M37R	1	Panel bracket, right
204-M76L	1	Panel bracket, left
204-M80	1	CRT support bracket
204-M83	1	Direct input bracket
205-14	1	Cover plate (on cabinet)
207-M1	2	CRT clamp
210-M1	1	Panel ring
Miscellaneous		
54-28	1	Power transformer
73-1	5	3/8" rubber grommet
73-2	1	3/4" rubber grommet
73-5	1	Rubber cushion strip
85-5F94	1	Circuit board
211-1	1	Handle
261-1	4	Rubber feet
390-16	1	Label set
413-1	1	Jewel
414-2	1	Grid screen
455-1	1	Pilot light bushing
481-1	1	Condenser mounting wafer
595-102	1	Manual

HELPFUL KIT BUILDING INFORMATION

Before attempting actual kit construction read the construction manual through thoroughly to familiarize yourself with the general procedure. Note the relative location of pictorials and pictorial inserts in respect to the progress of the assembly procedure outlined.

This information is offered primarily for the convenience of novice builders and will be of definite assistance to those lacking thorough knowledge of good construction practices. Even the advanced electronics enthusiast may benefit by a brief review of this material before proceeding with kit construction. In the majority of cases, failure to observe basic instruction fundamentals is responsible for inability to obtain desired level of performance.

RECOMMENDED TOOLS

The successful construction of Heathkits does not require the use of specialized equipment and only basic tools are required. A good quality electric soldering iron is essential. The preferred size would be a 100 watt iron with a small tip. The use of long nose pliers and diagonal or side cutting pliers is recommended. A small screw driver will prove adequate and several additional assorted screw drivers will be helpful. Be sure to obtain a good supply of rosin core type radio solder. Never use separate fluxes, paste or acid solder in electronic work.

ASSEMBLY

In the actual mechanical assembly of components to the chassis and panel, it is important that the procedure shown in the manual be carefully followed. Make sure that tube sockets are properly mounted in respect to keyway or pin numbering location. The same applies to transformer mountings so that the correct transformer color coded wires will be available at the proper chassis opening.

Make it a standard practice to use lock washers under all 6-32 and 8-32 nuts. The only exception being in the use of solder lugs—the necessary locking feature is already incorporated in the design of the solder lugs. A control lock washer should always be used between the control and the chassis to prevent undesirable rotation in the panel. To improve instrument appearance and to prevent possible panel marring use a control flat nickel washer under each control nut.

When installing binding posts that require the use of fiber insulating washers, it is good practice to slip the shoulder washer over the binding post mounting stud before installing the mounting stud in the panel hole provided. Next, install a flat fiber washer and a solder lug under the mounting nut. Be sure that the shoulder washer is properly centered in the panel to prevent possible shorting of the binding post.

WIRING

When following wiring procedure make the leads as short and direct as possible. In filament wiring requiring the use of a twisted pair of wires allow sufficient slack in the wiring that will permit the twisted pair to be pushed against the chassis as closely as possible thereby affording relative isolation from adjacent parts and wiring.

























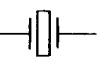
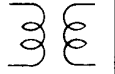



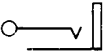

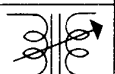
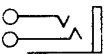
When removing insulation from the end of hookup wire, it is seldom necessary to expose more than a quarter inch of the wire. Excessive insulation removal may cause a short circuit condition in respect to nearby wiring or terminals. In some instances, transformer leads of solid copper will have a brown baked enamel coating. After the transformer leads have been trimmed to a suitable length, it is necessary to scrape the enamel coating in order to expose the bright copper wire before making a terminal or soldered connection.

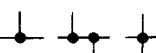
In mounting parts such as resistors or condensers, trim off all excess lead lengths so that the parts may be installed in a direct point-to-point manner. When necessary use spaghetti or insulated sleeving over exposed wires that might short to nearby wiring.

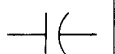
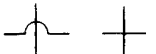
It is urgently recommended that the wiring dress and parts layout as shown in the construction manual be faithfully followed. In every instance, the desirability of this arrangement was carefully determined through the construction of a series of laboratory models.

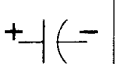
SOLDERING

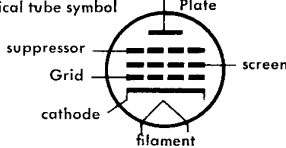
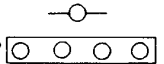
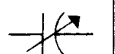
Much of the performance of the kit instrument, particularly in respect to accuracy and stability, depends upon the degree of workmanship used in making soldered connections. Proper soldered connections are not at all difficult to make but it would be advisable to observe a few precautions. First of all before a connection is to be soldered, the connection itself should be clean and mechanically strong. Do not depend on solder alone to hold a connection together. The tip of the soldering iron should be bright, clean and free of excess solder. Use enough heat to thoroughly flow the solder smoothly into the joint. Avoid excessive use of solder and do not allow a flux flooding condition to occur which could conceivably cause a leakage path between adjacent terminals on switch assemblies and tube sockets. This is particularly important in instruments such as the VTVM, oscilloscope and generator kits. Excessive heat will also burn or damage the insulating material used in the manufacture of switch assemblies. Be sure to use only good quality rosin core radio type solder.

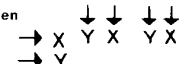
Antenna General		Resistor General		Neon Bulb		Receptacle two-conductor	
Loop		Resistor Tapped		Illuminating Lamp		Battery	
Ground		Resistor Variable		Switch Single pole Single throw		Fuse	
Inductor General		Potentiometer		Switch double pole single throw		Piezoelectric Crystal	
Air core Transformer General		Thermistor		Switch Triple pole Double throw		1000 =	K
Adjustable Powdered Iron Core		Jack two conductor		Switch Multipoint or Rotary		1,000,000 =	M
Magnetic Core Variable Coupling		Jack three conductor		Speaker		OHM =	Ω
Iron Core Transformer		Wires connected		Rectifier		Microfarad =	MF
Capacitor General		Wires Crossing but not connected		Microphone		Micro Microfarad =	MMF
Capacitor Electrolytic		A. Ammeter V. Voltmeter		Typical tube symbol		Binding post Terminal strip	
Capacitor Variable		G. Galvanometer MA. Milliammeter uA. Microammeter, etc.				Wiring between like letters is	

HEATH COMPANY

A Subsidiary of Daystrom Inc.

THE WORLD'S FINEST ELECTRONIC EQUIPMENT IN KIT FORM

BENTON HARBOR, MICHIGAN